

1

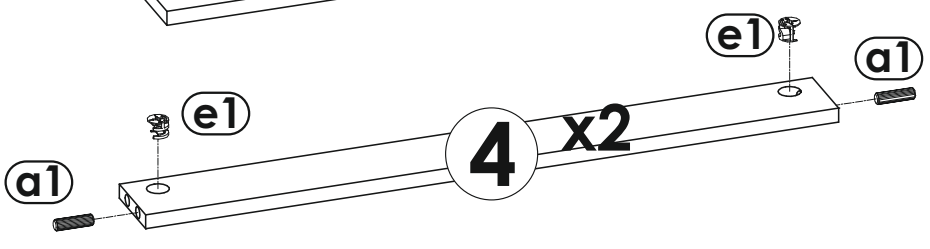

2
▼

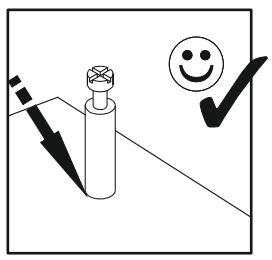
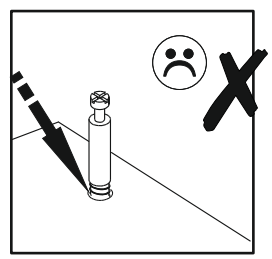
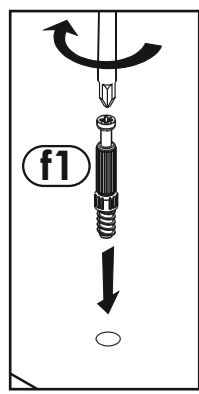
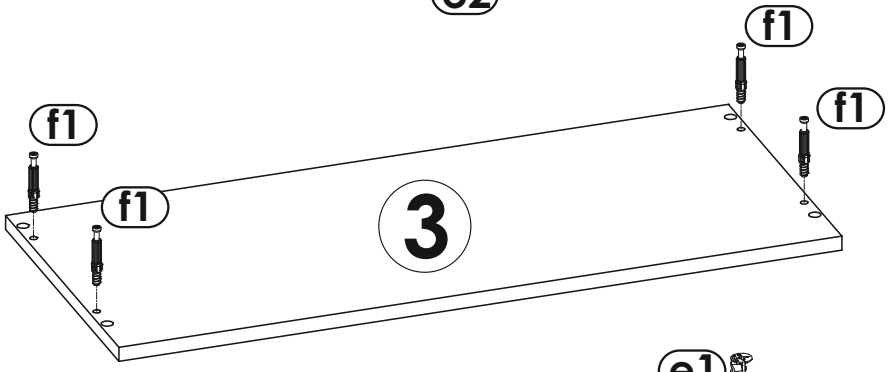
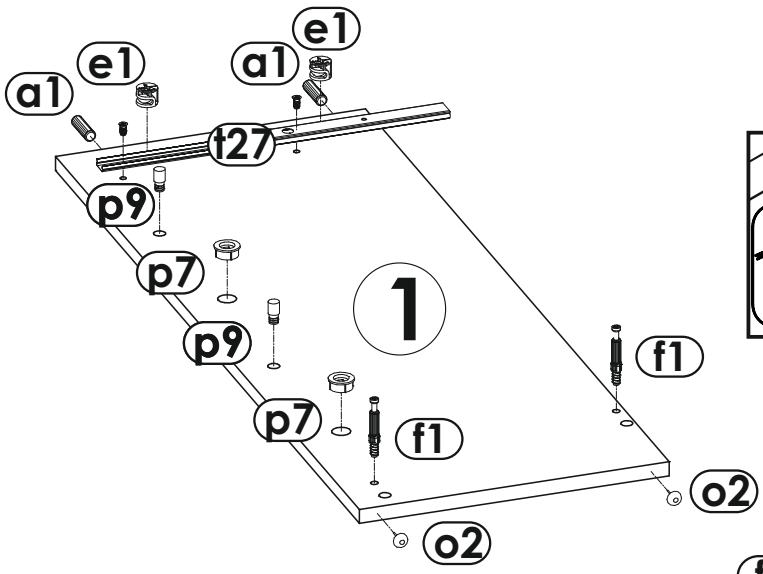
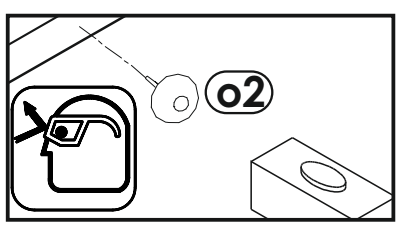
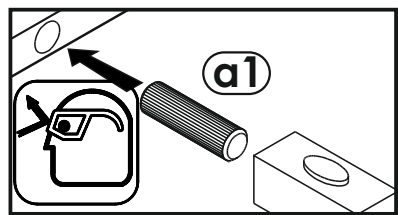
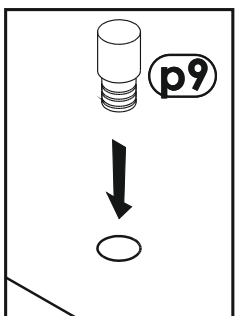
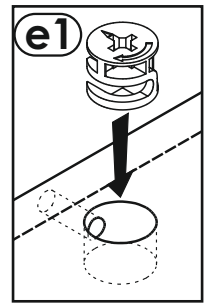
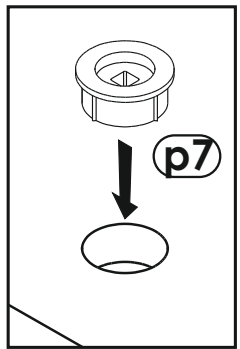
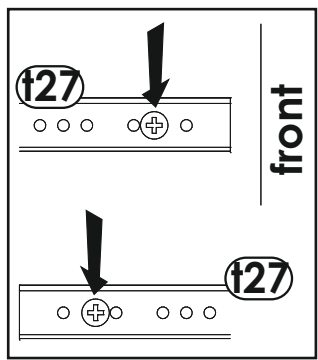
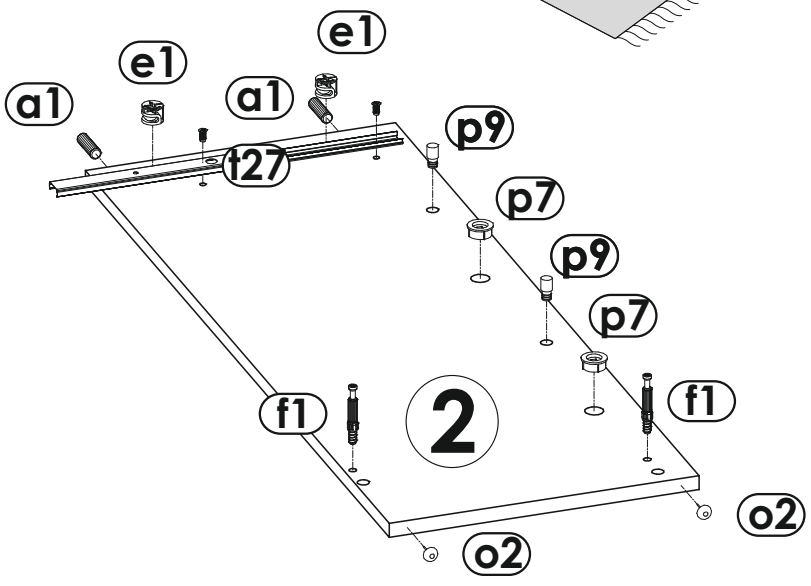
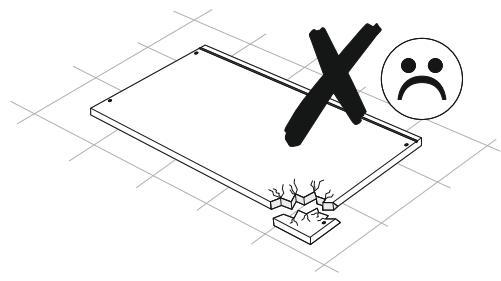
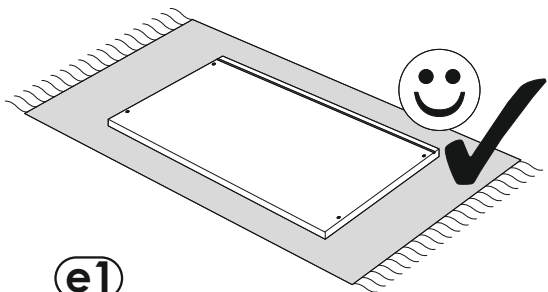
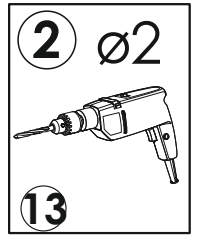
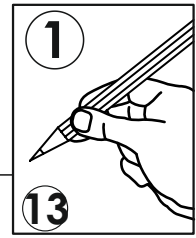
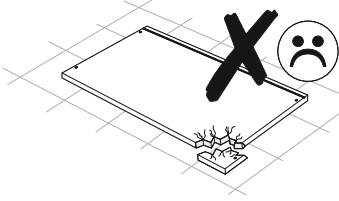
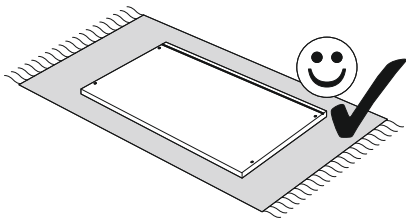

a)

x2

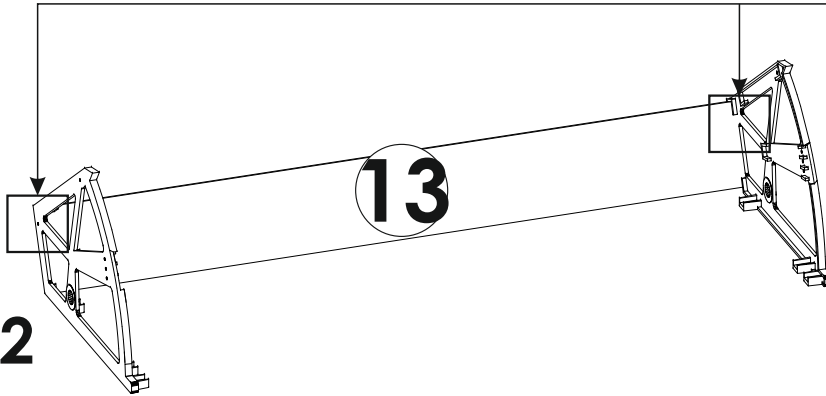

b)

x2

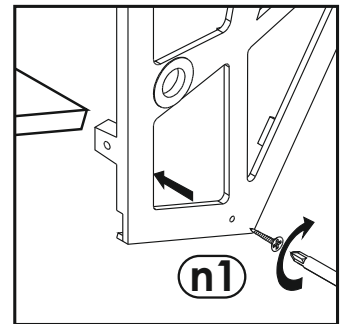
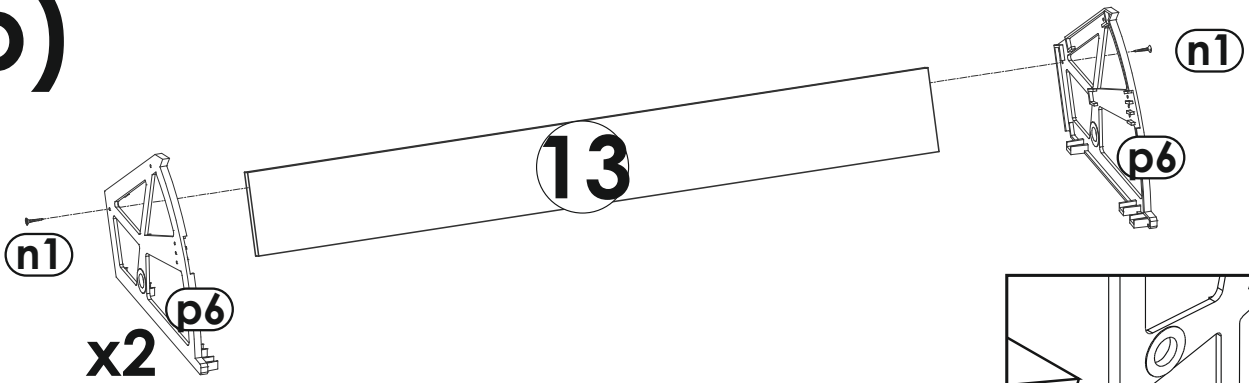

c)

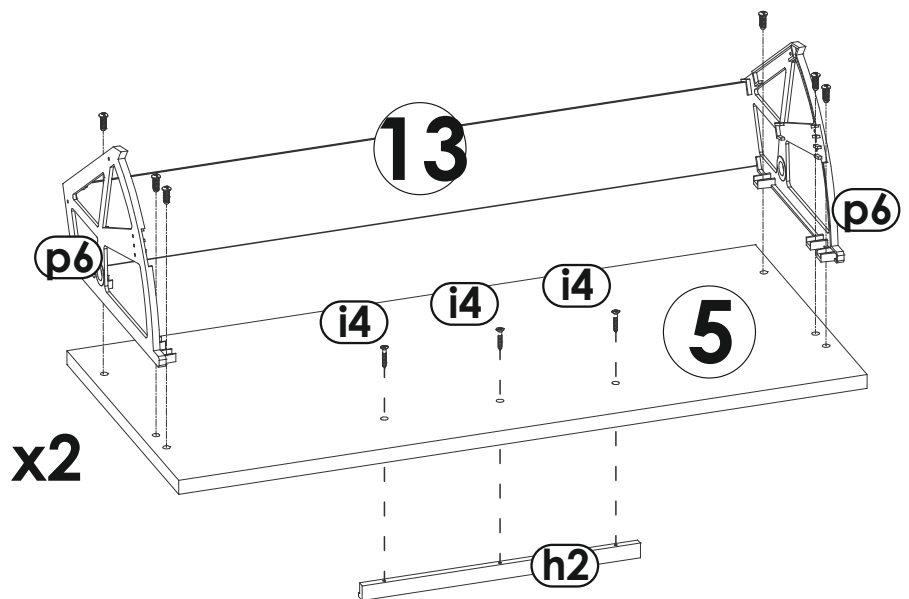
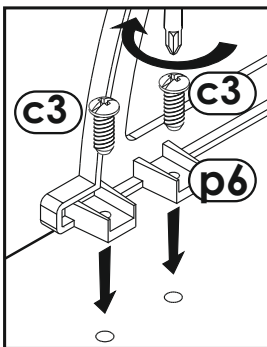

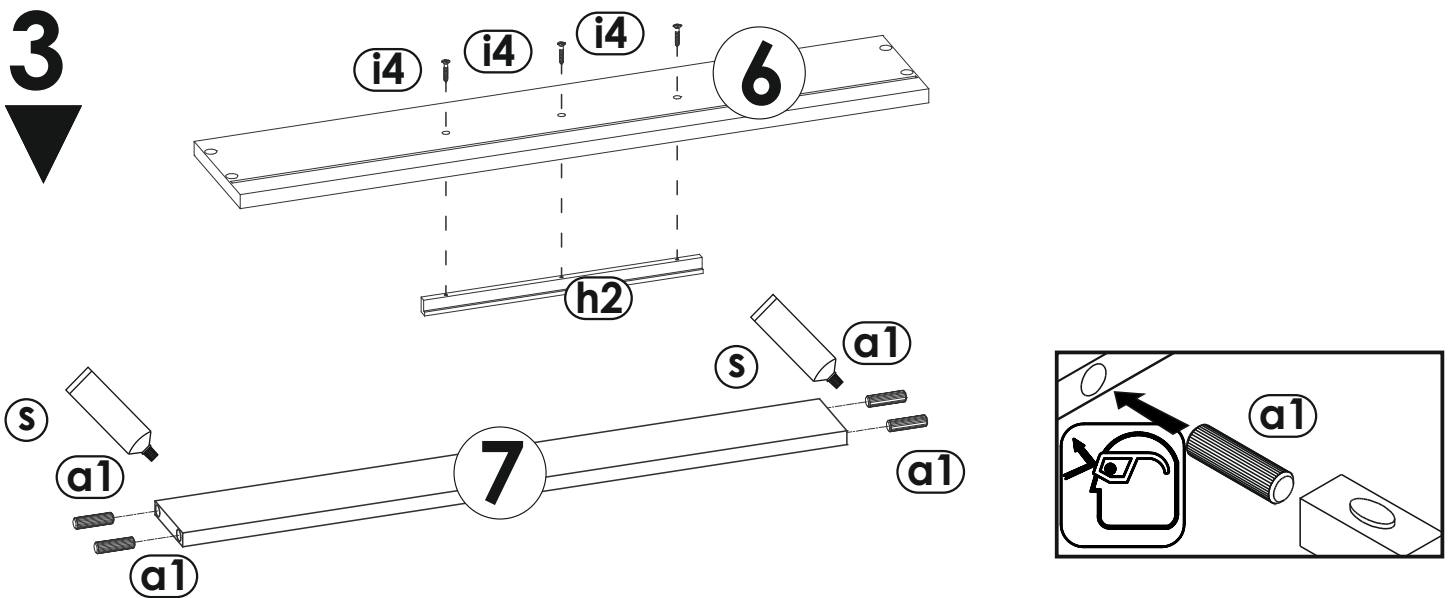
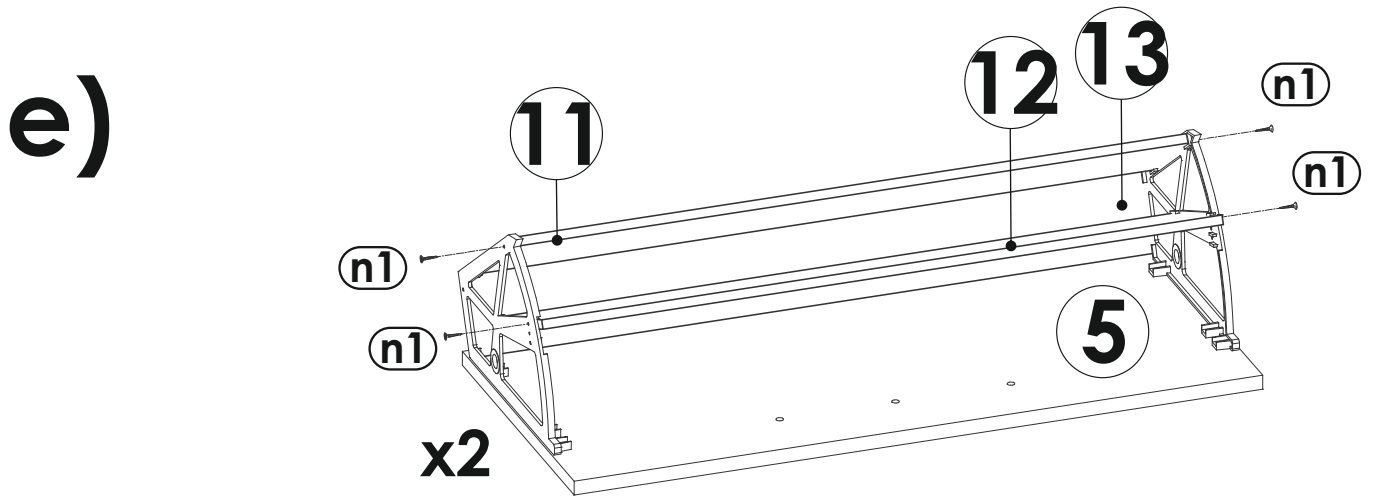
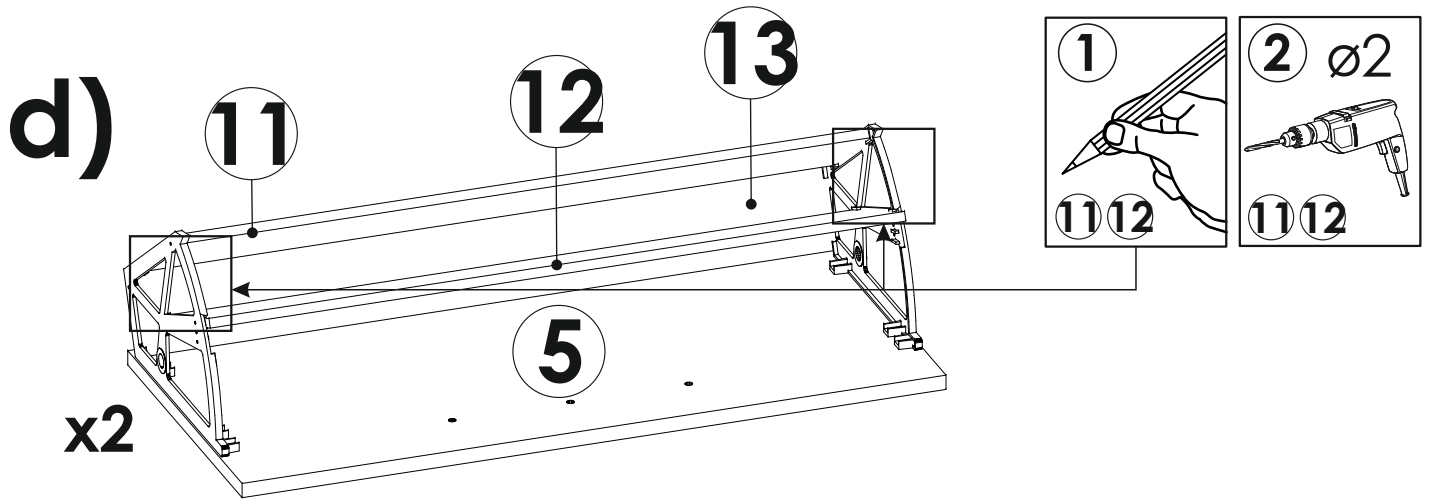

4

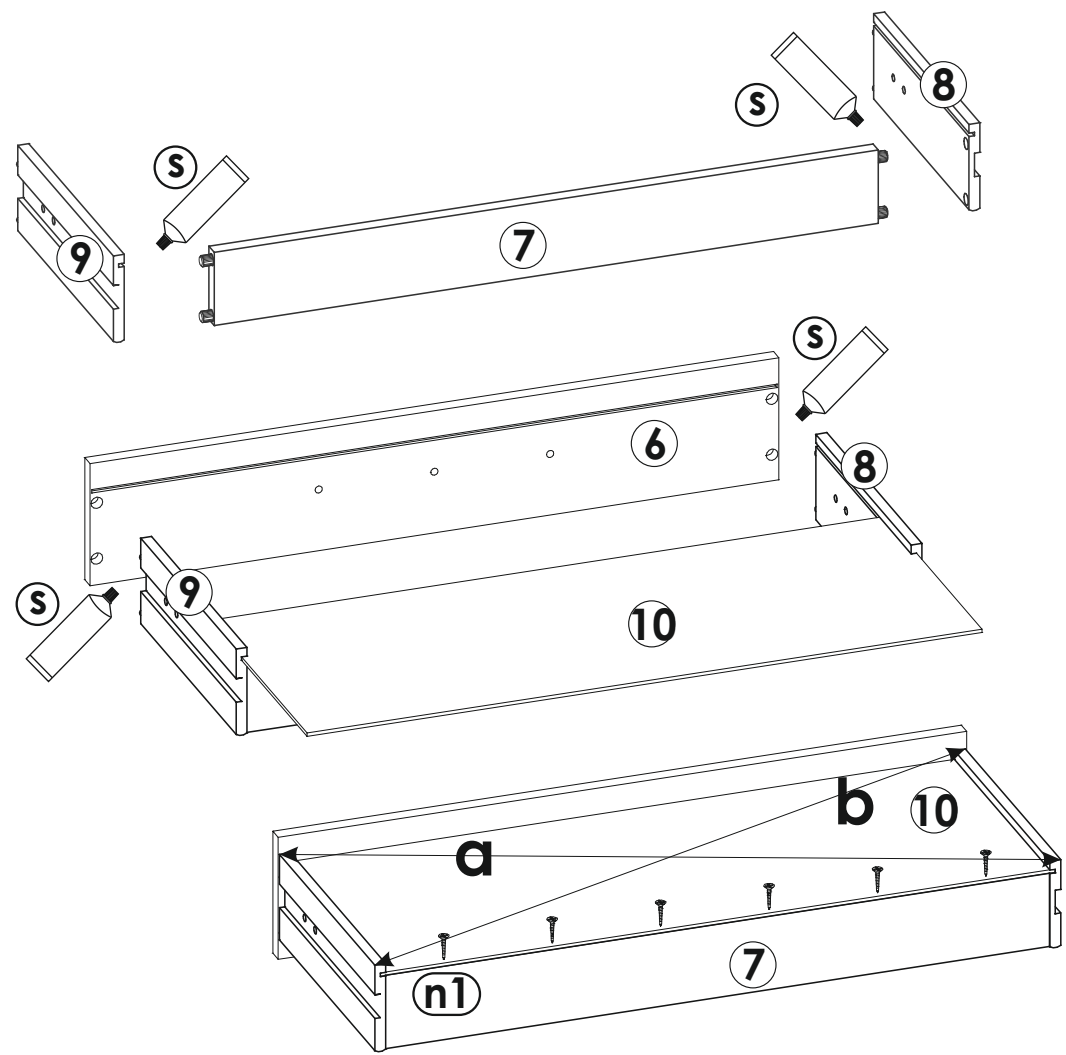
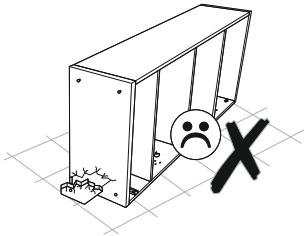
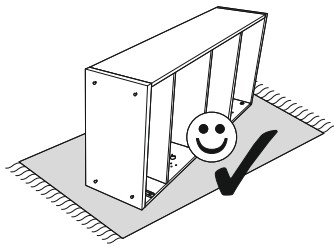

5

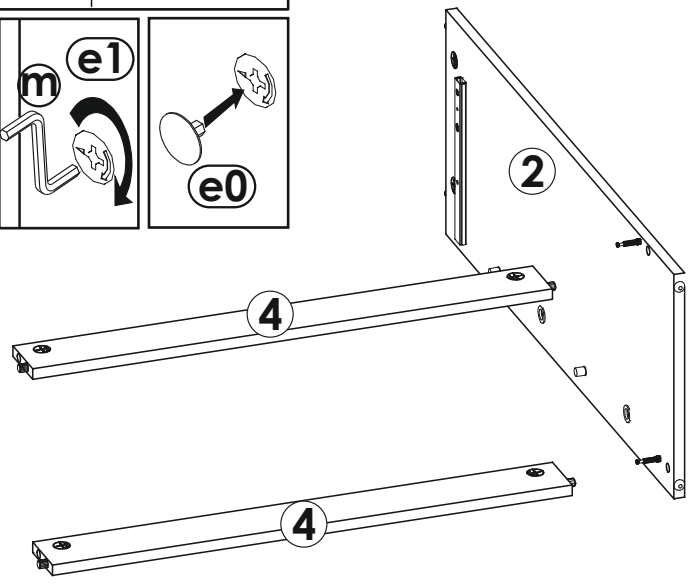
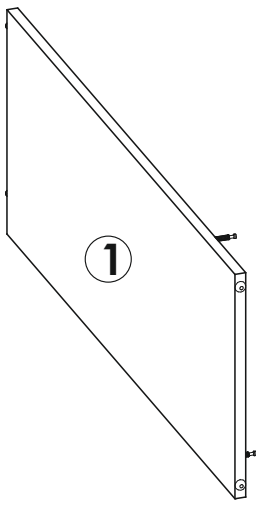
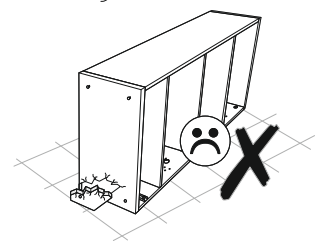
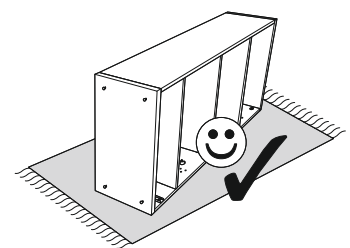
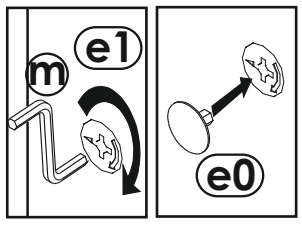
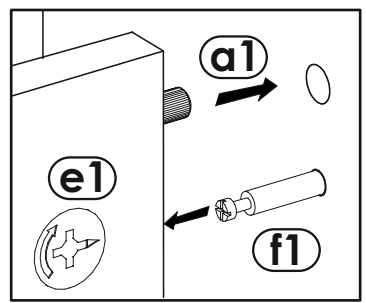

6

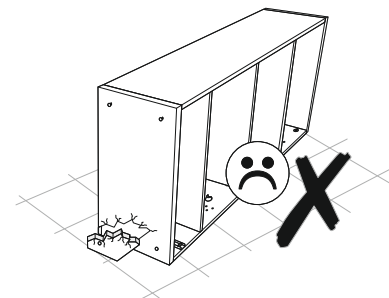
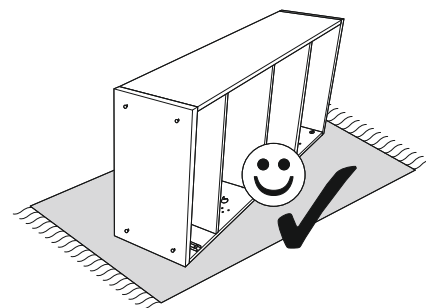
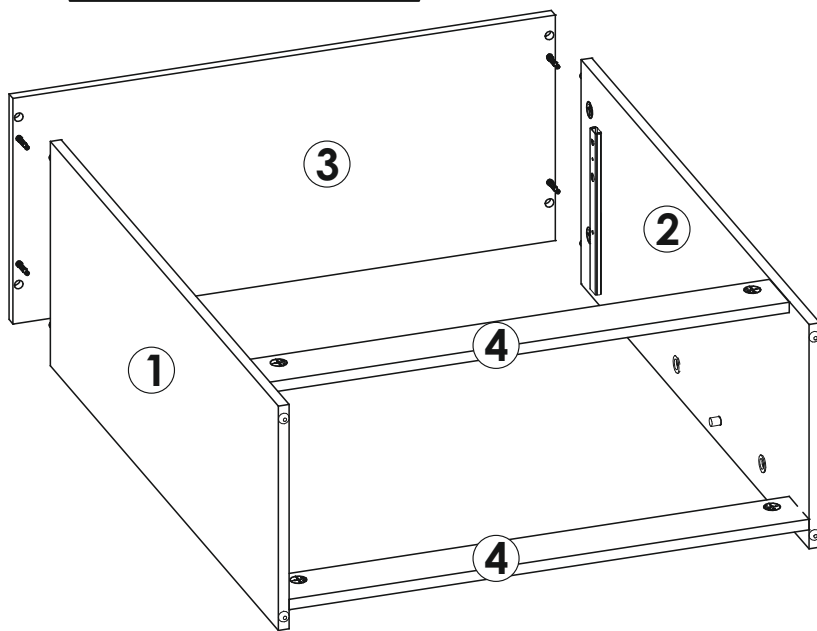
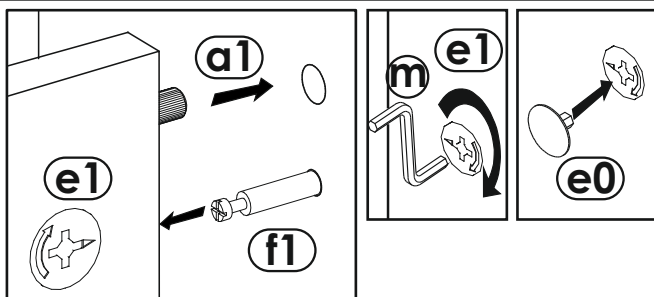

7

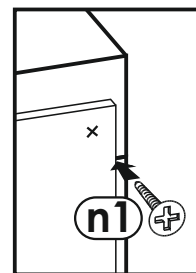
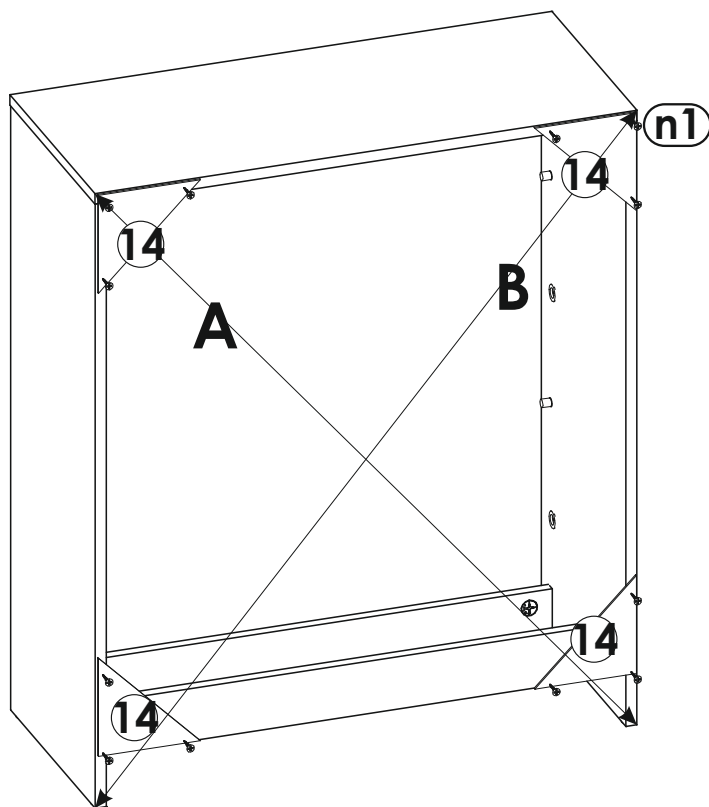

8
▼

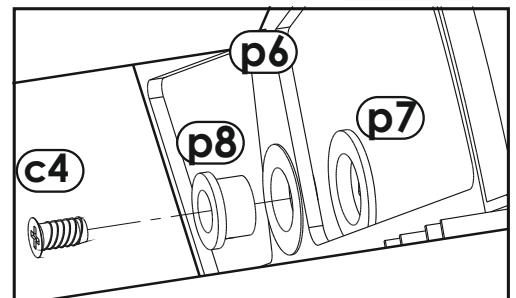
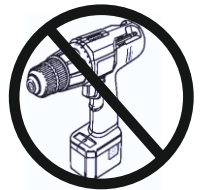
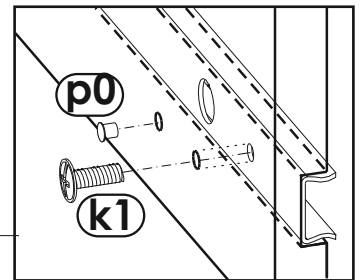
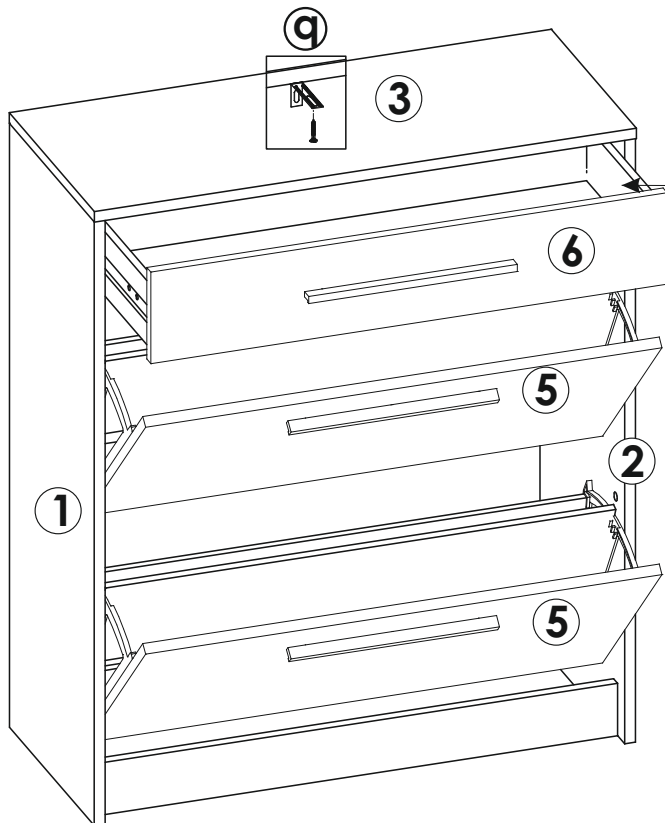
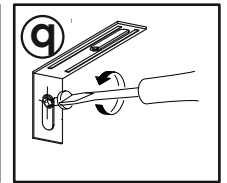
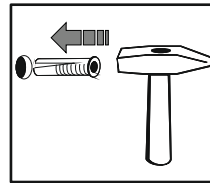
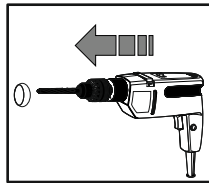
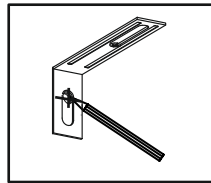
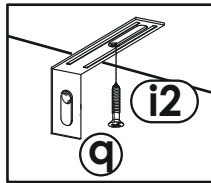

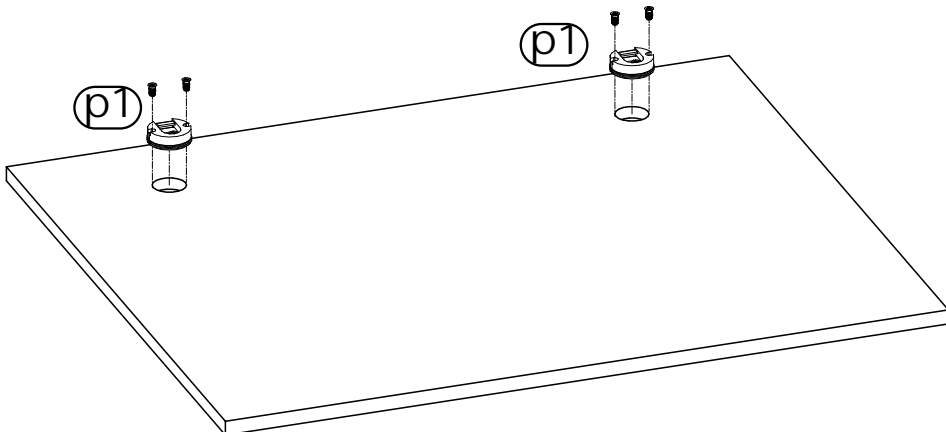
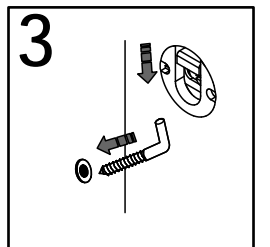
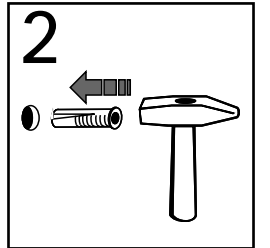
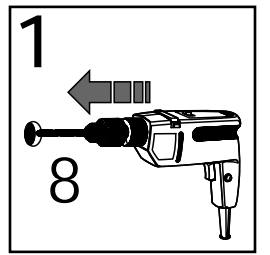
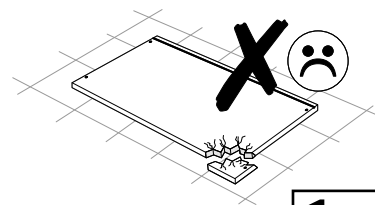
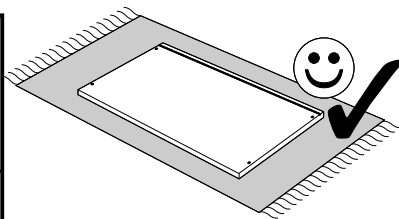
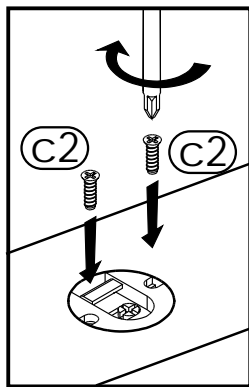
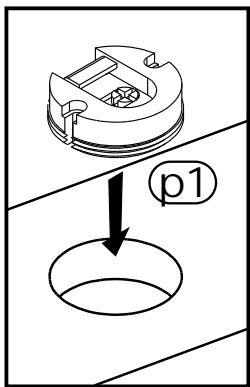
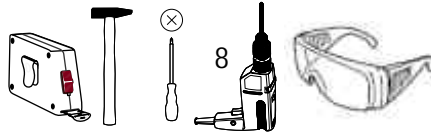
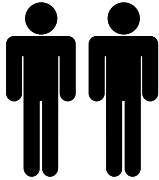
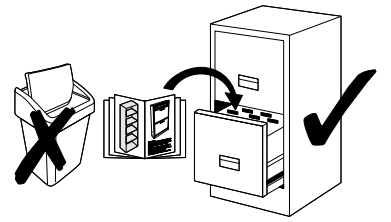
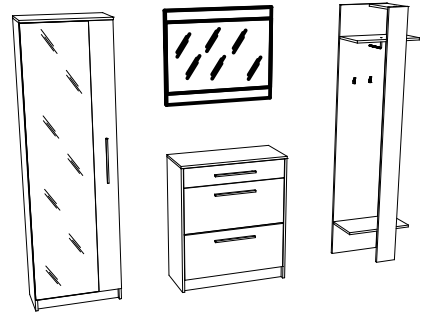
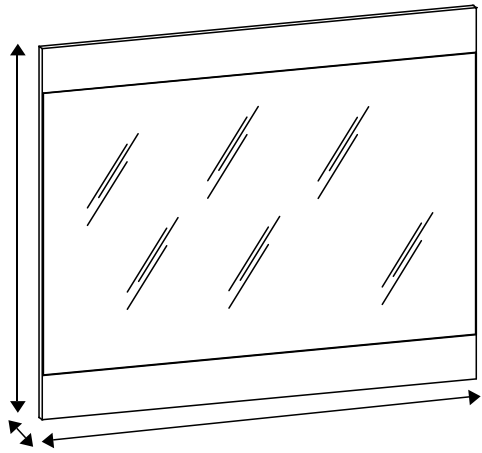

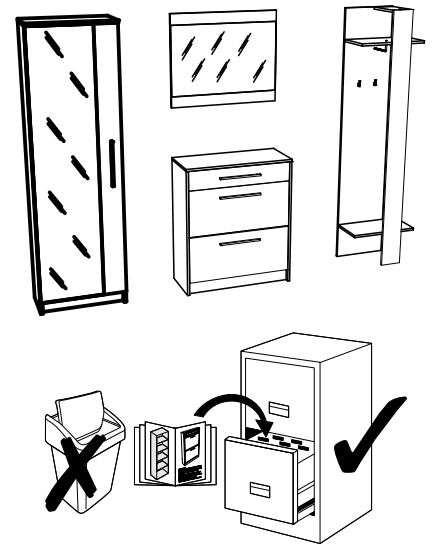
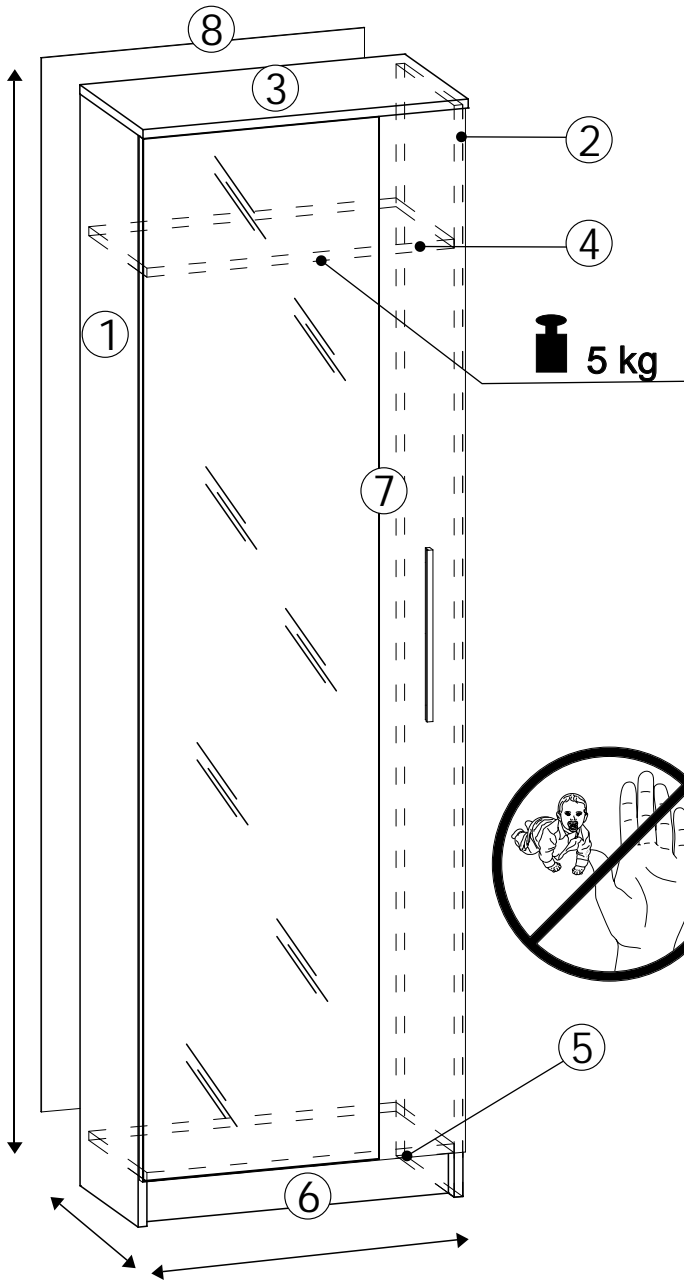

a1 8x35 x....(x16)	b0 x....(x3)	b1 x....(x3)		
c1 Euro 4x13 x....(x6)	e0 x....(x12)	e1 x....(x12)	f1 x....(x12)	
h2 x....(x1)				
i4 3.5x27 x....(x3)	i2 4x16 x....(x5)	m x....(x1)	n1 3x16 x....(x40)	o2 x....(x4)
p0 x....(x6)	p10 L-250 x....(x1)	q x....(x1)		

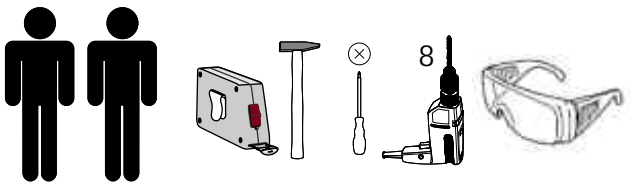

- ① - C2 ⑤ - C1
 - ② - C2 ⑥ - C2
 - ③ - C1 ⑦ - C2
 - ④ - C1 ⑧ - C2
- C1 = 1/2
- C2 = 2/2

1

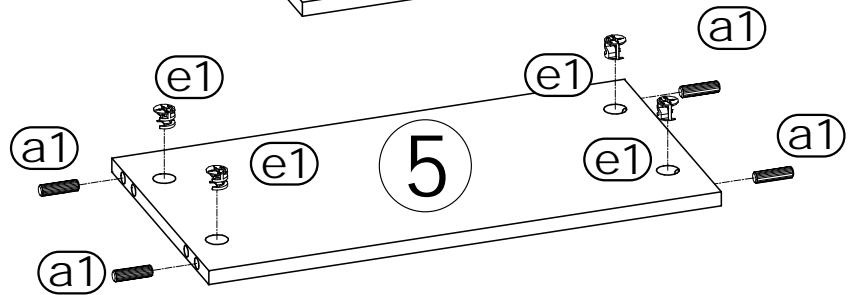
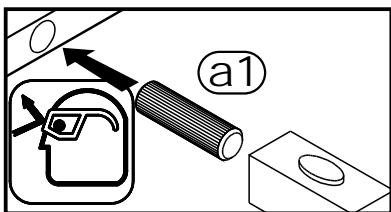
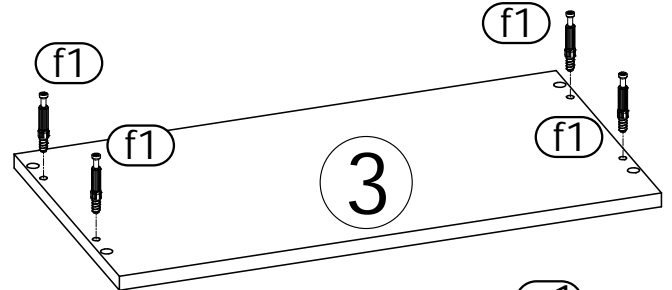
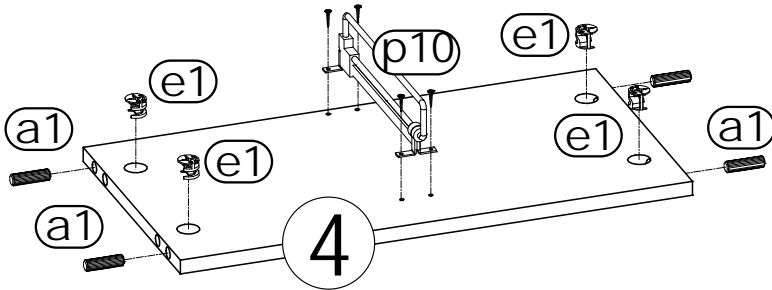
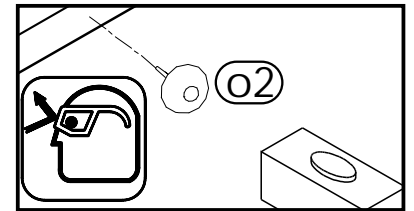
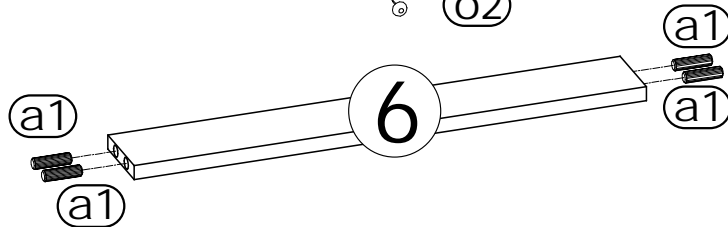
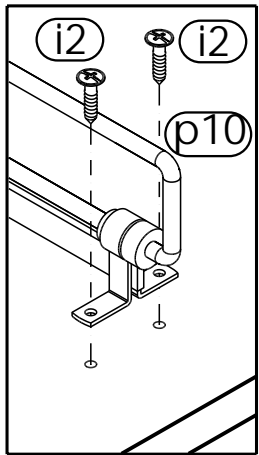
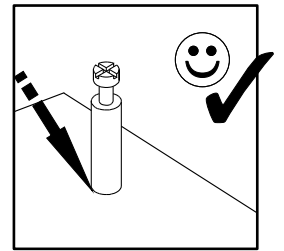
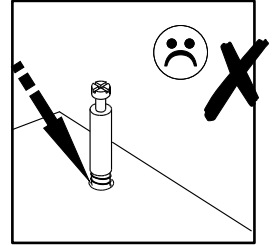
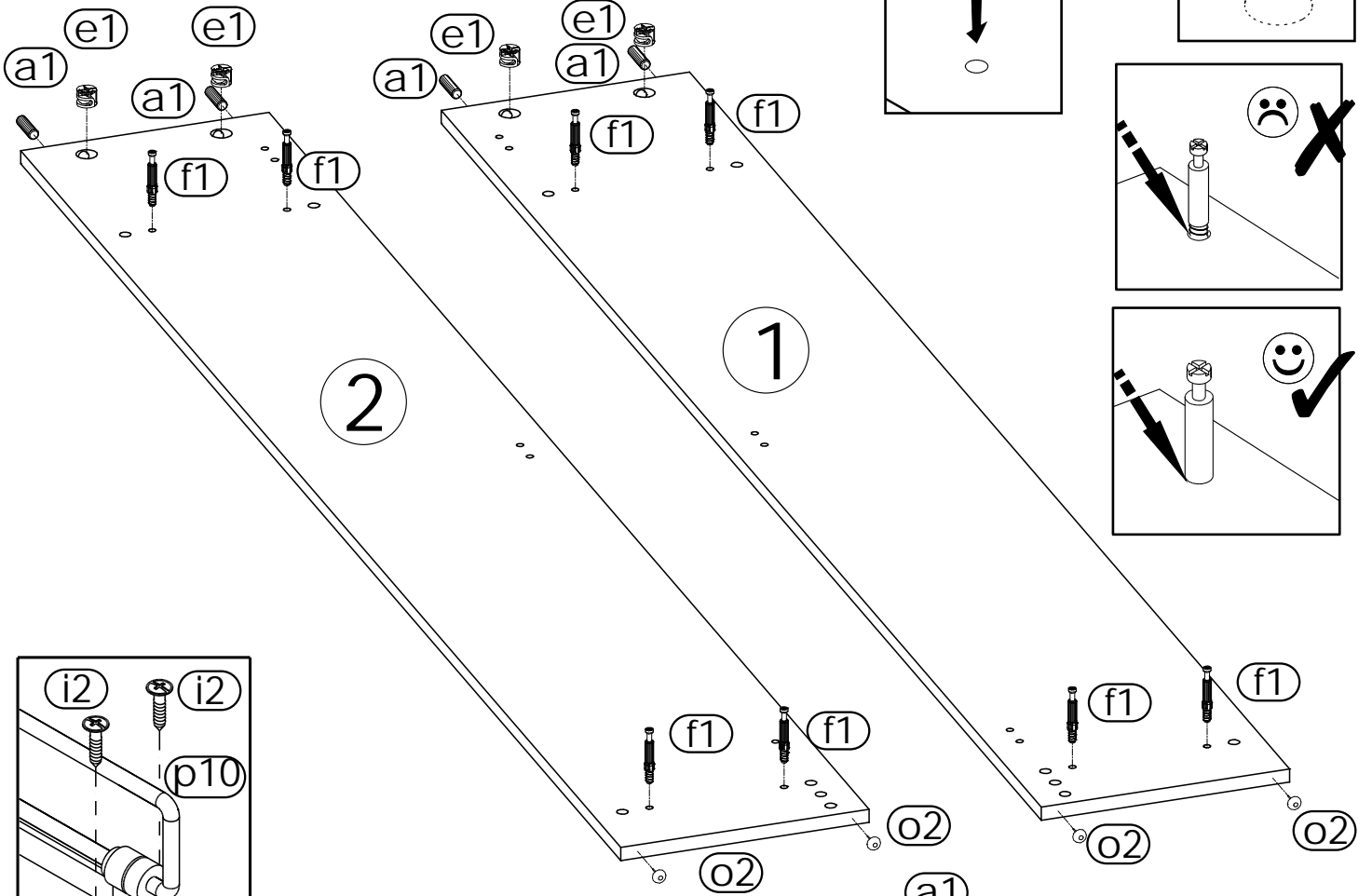
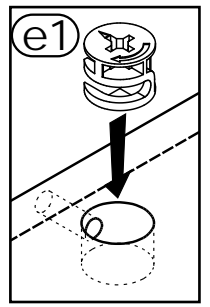
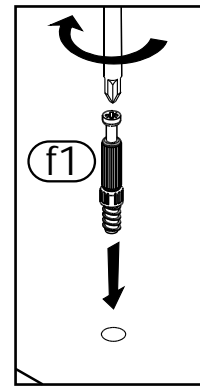
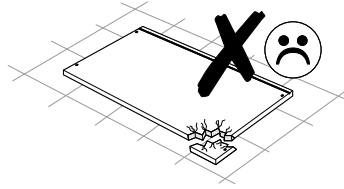
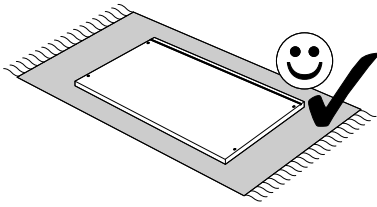

2

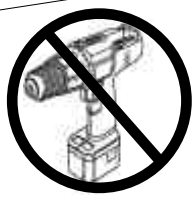
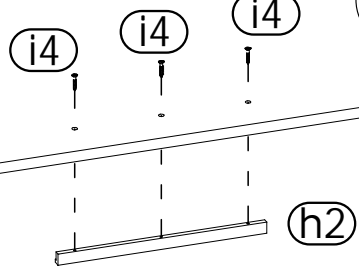
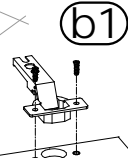
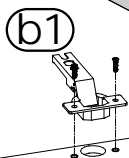
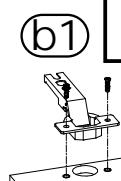
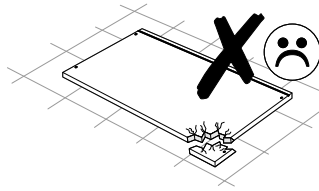
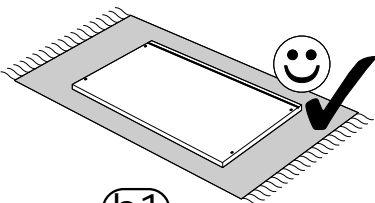
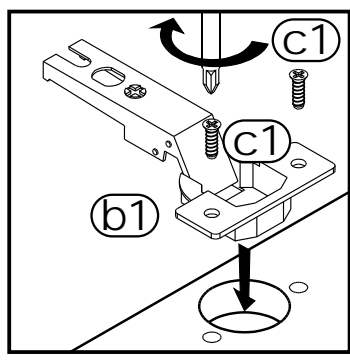

3

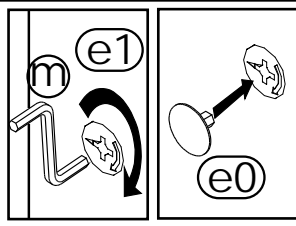
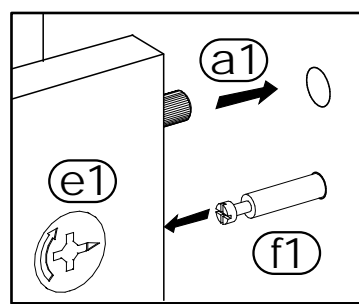
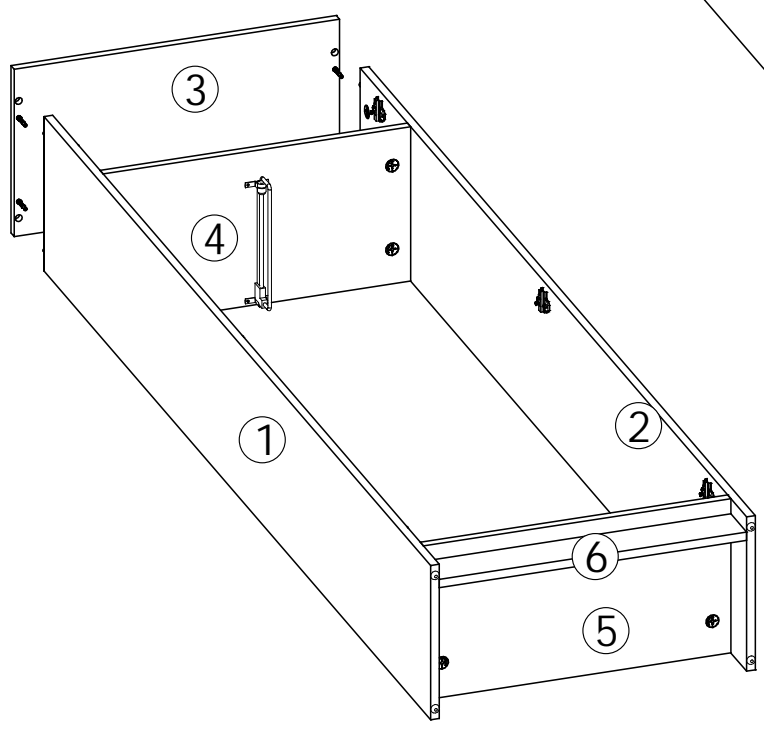
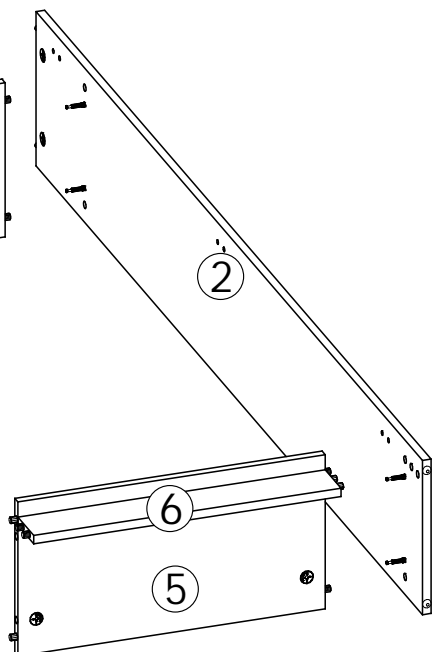
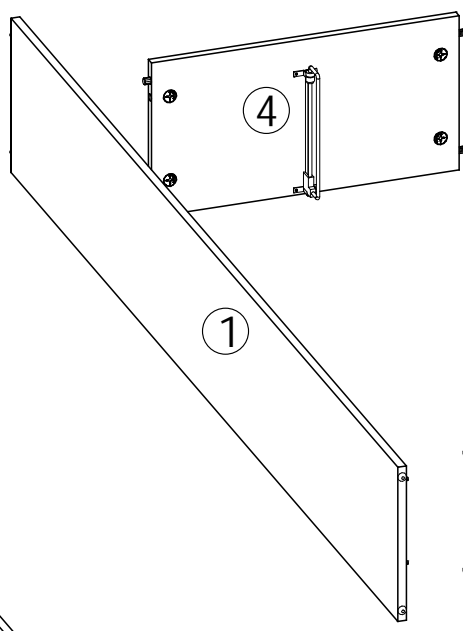
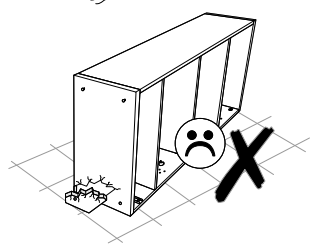
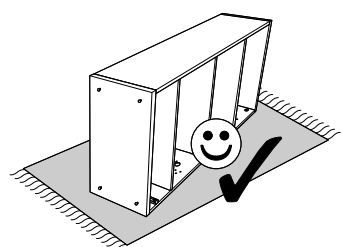

4
▼

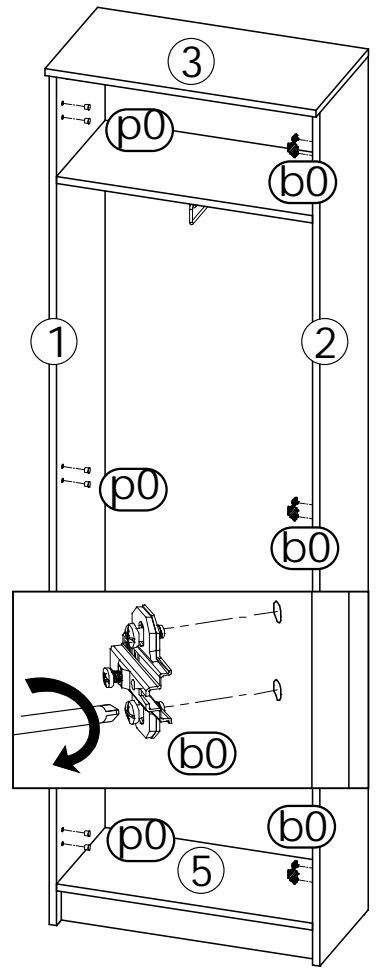
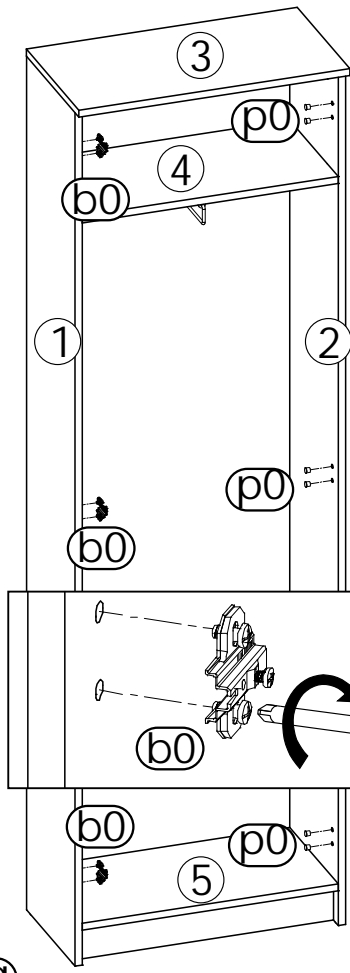
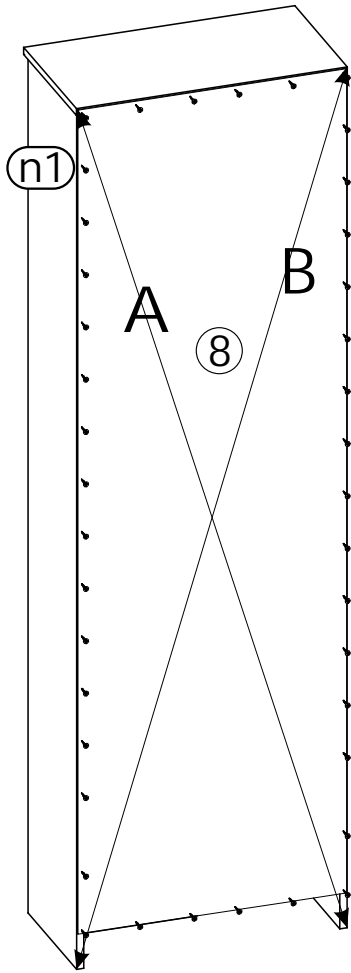
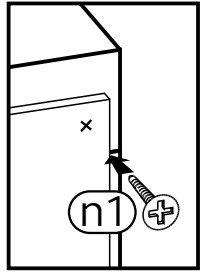

5
▼

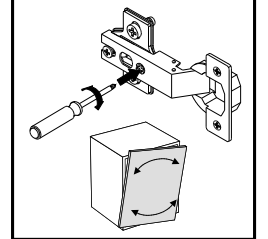
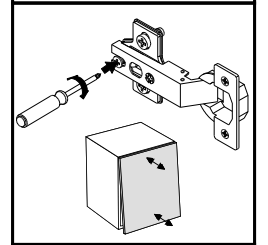
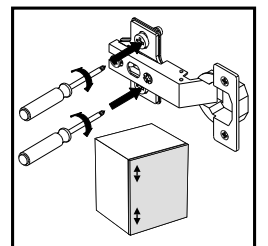
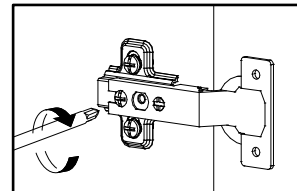
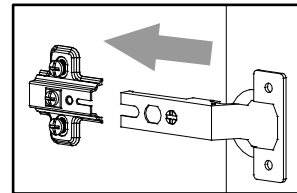
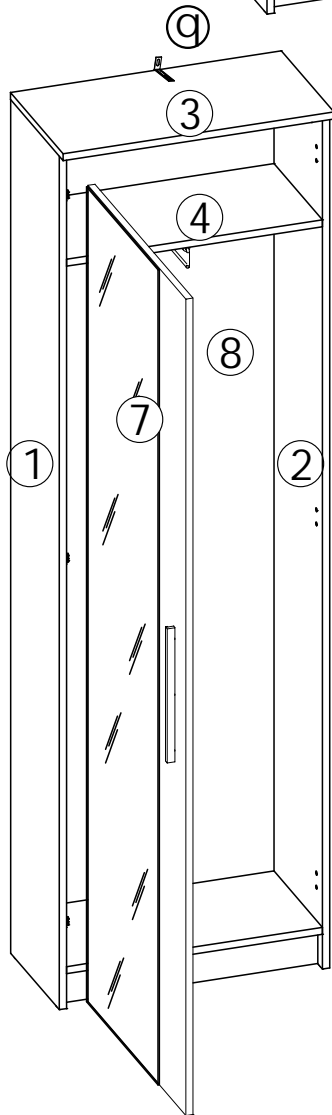
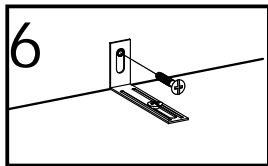
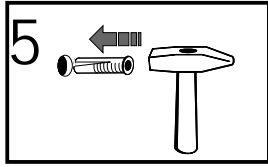
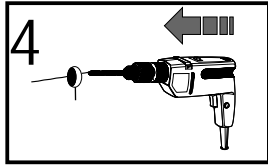
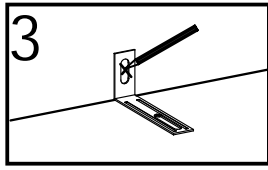
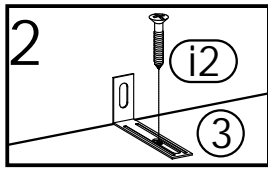
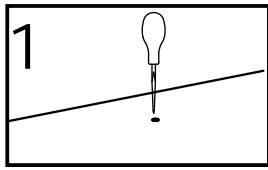

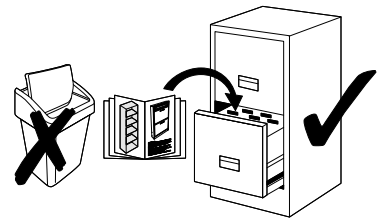
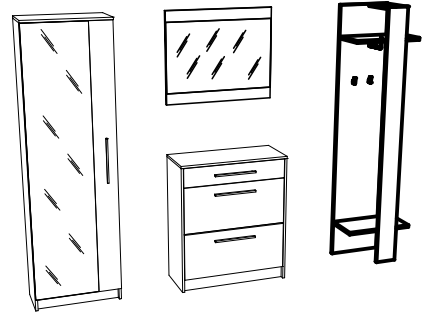
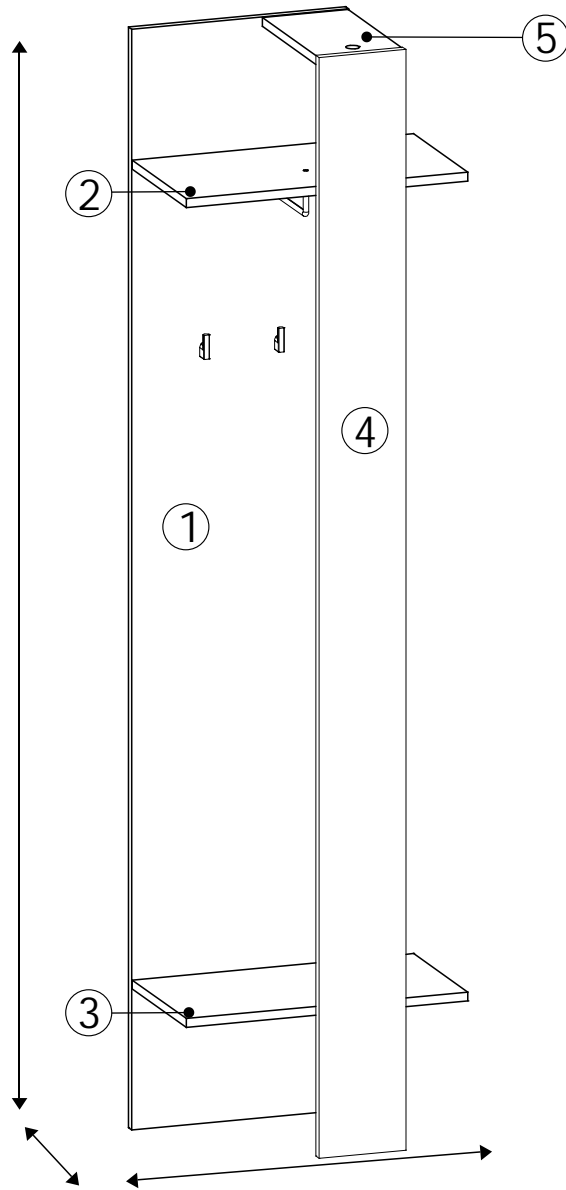

a1 8x35 x...(x14)	c2 Euro 5x13 x...(x4)	e0 x...(x3)	e1 x...(x3)	f1 x...(x3)	g0 x...(x5)	g1 7x50 x...(x5)	h4 x...(x2)	i2 4x16 x...(x1)
i1 4x35 x...(x2)	i12 4x30 x...(x4)	m x...(x1)	o2 x...(x4)	p1 x...(x2)	p3 x...(x1)	q x...(x1)		

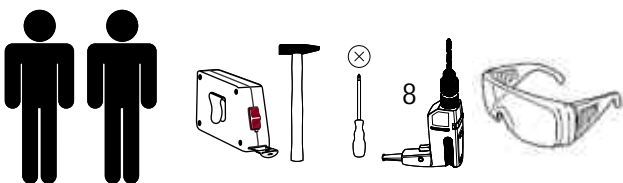

1

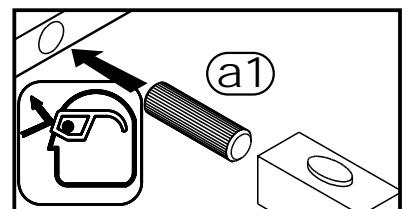
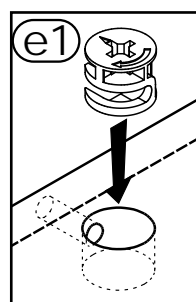
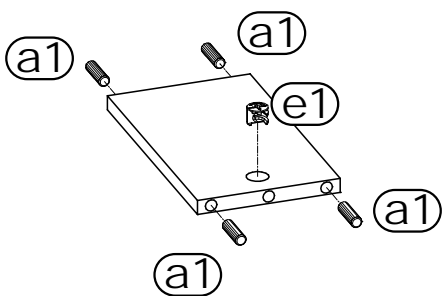
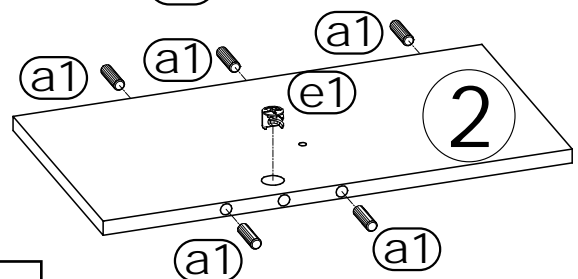
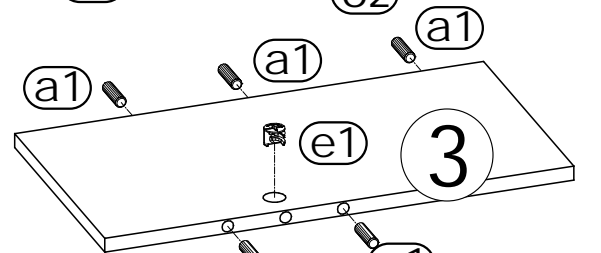
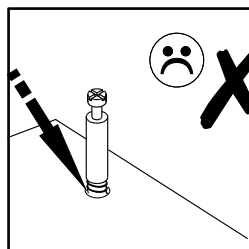
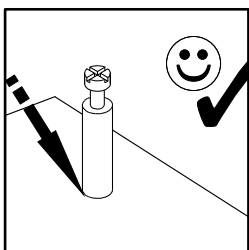
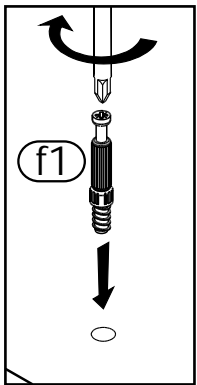
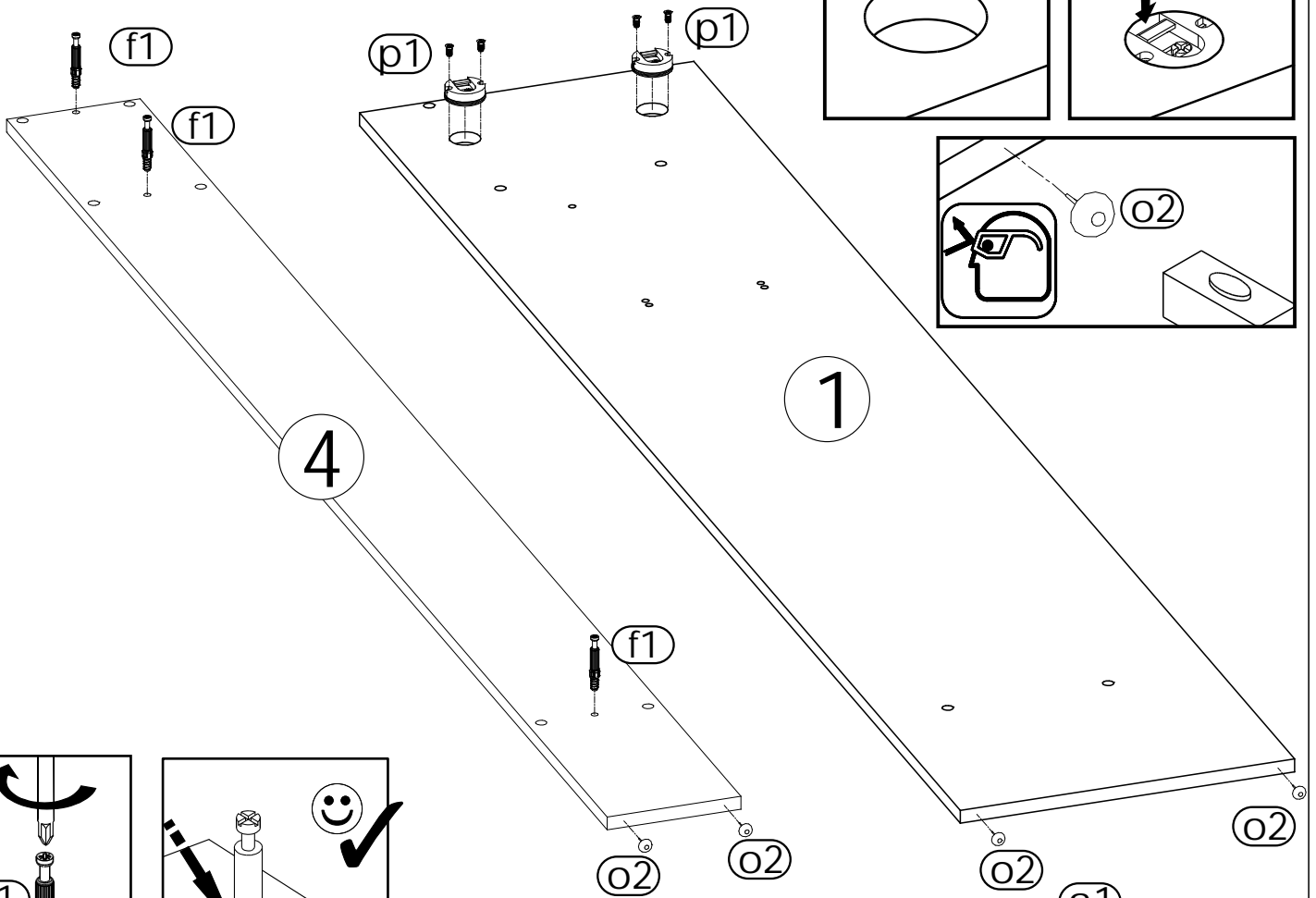
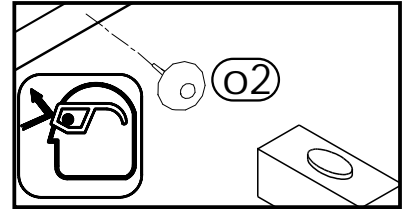
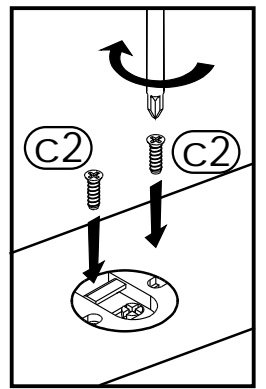
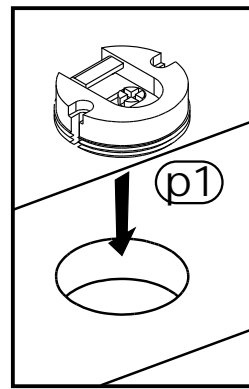
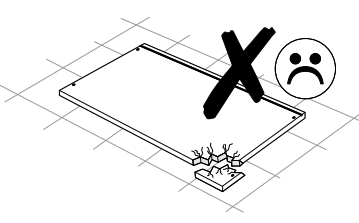
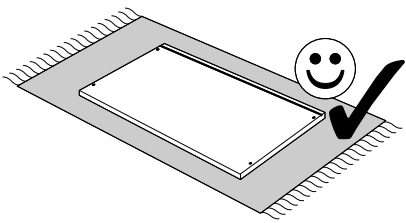

2

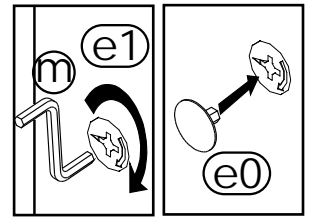
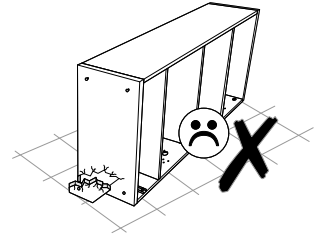
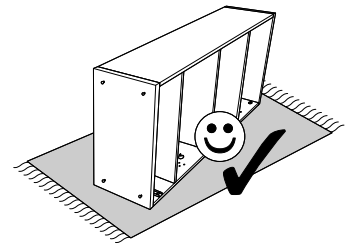
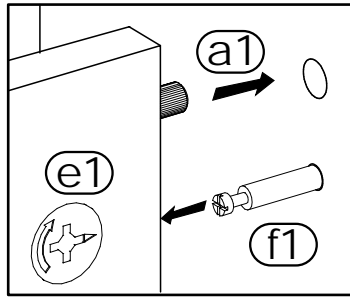
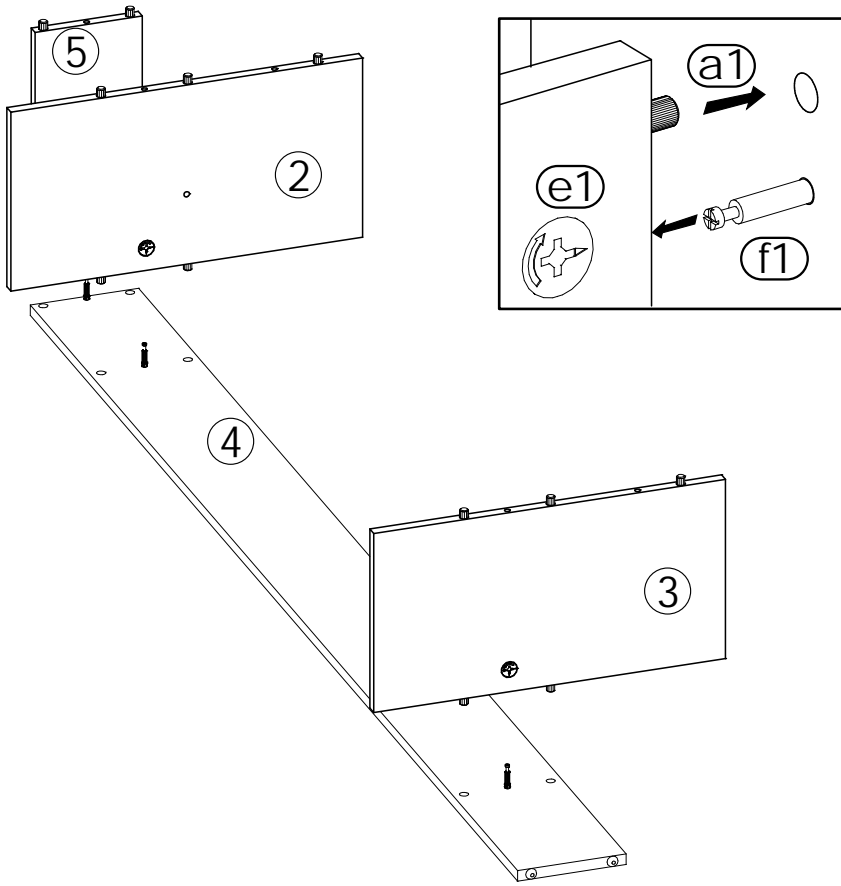

3

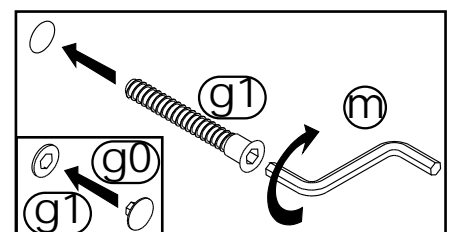
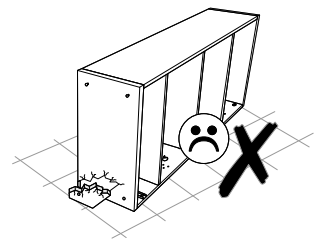
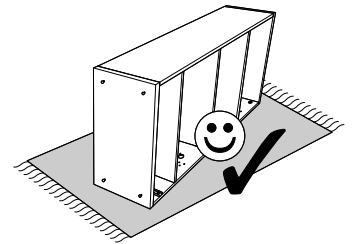
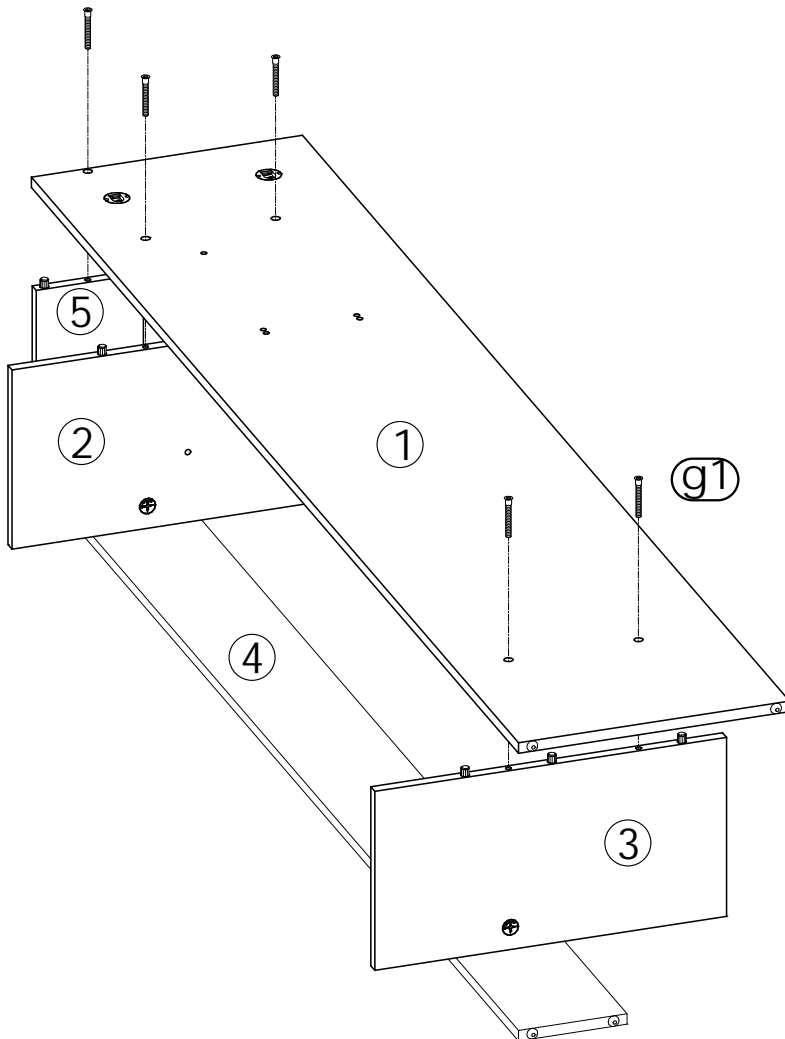

4

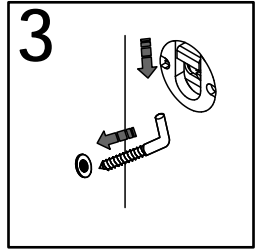
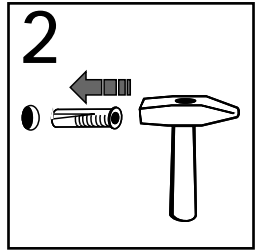
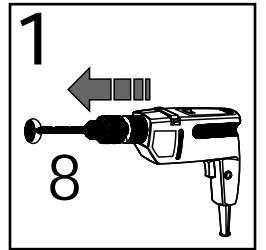
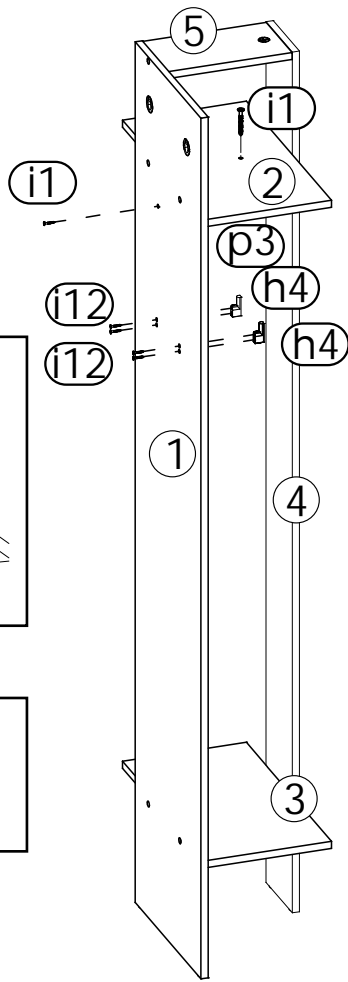
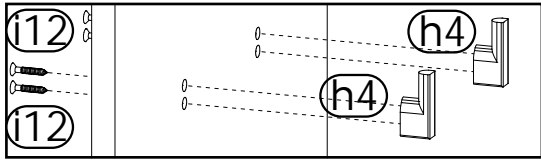
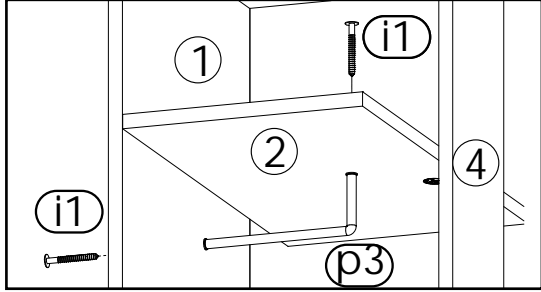
5