

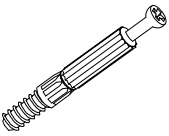





<p>4066</p>  <p>Ø6.5x36.5mm x12</p>	<p>3996</p>  <p>Ø15x16mm x12</p>	<p>136236</p>  <p>Ø20 x12</p>	<p>3989</p>  <p>Ø8x30mm x12</p>
<p>4017</p>  <p>x8</p>	<p>3879</p>  <p>Ø6.3x13mm x4</p>	<p>3923</p>  <p>Ø4,0x16mm x32</p>	<p>4044</p>  <p>x16</p>
<p>4057</p>  <p>x6</p>	<p>IN01112</p>  <p>H-20 mm x1</p>	<p>3884</p>  <p>x6</p>	<p>IN01032</p>  <p>H-18 mm x6</p>
<p>3984</p>  <p>4 mm x1</p>	<p>IN01007</p>  <p>x4</p>	<p>IN01006</p>  <p>x4</p>	<p>IN00378</p>  <p>L-1566 mm x1</p>
<p>71900</p>  <p>x2</p>	<p>83656</p>  <p>L-1566mm x4</p>	<p>3912</p>  <p>Ø3,0x13mm x20</p>	<p>3919</p>  <p>Ø3,5x20mm x5</p>

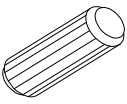
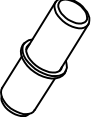
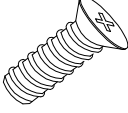
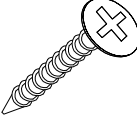
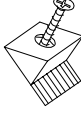
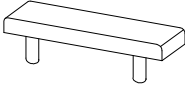
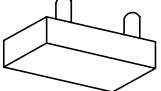
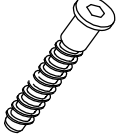

# 1

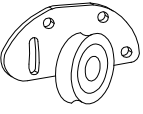
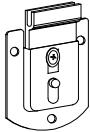
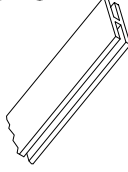
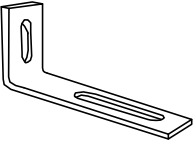
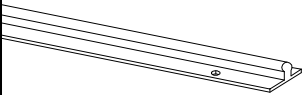
4057

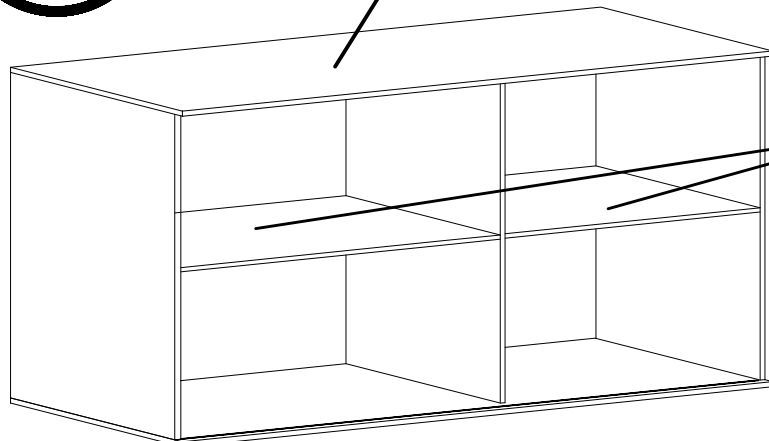
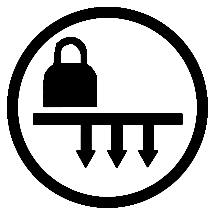
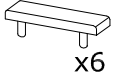

x6

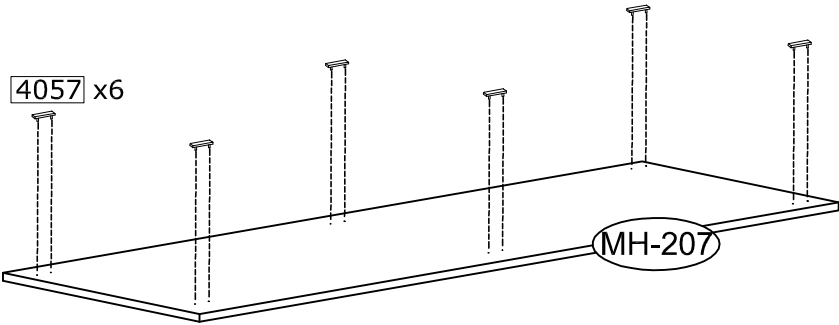
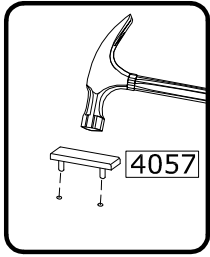

# 2

4066



x6

83656

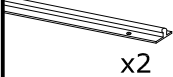

x2

3912



3,0X13 x10

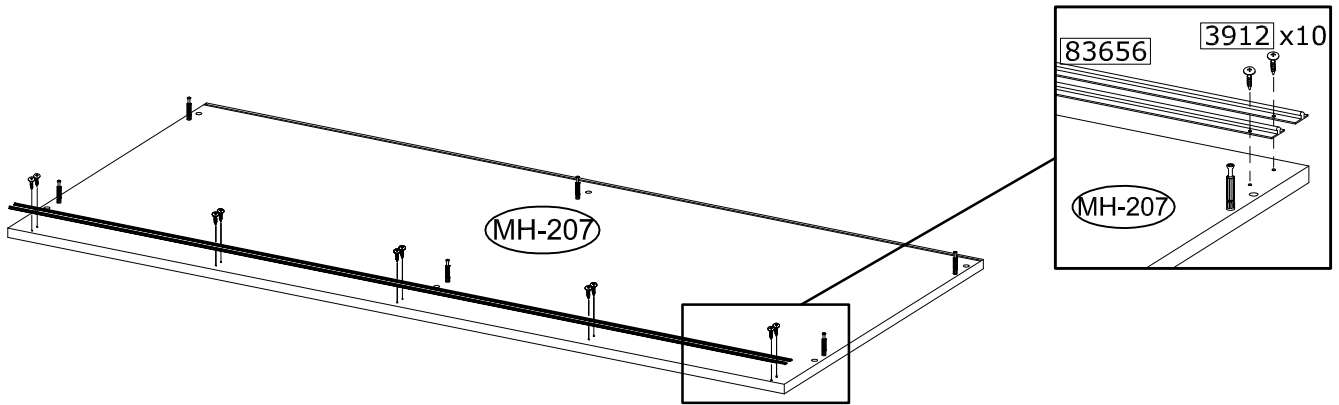
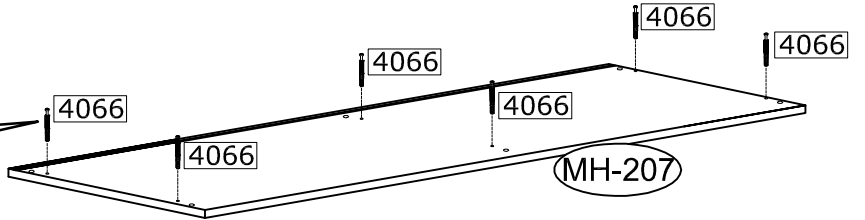
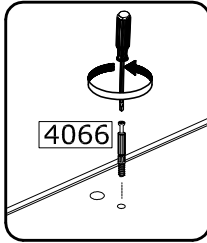

# 3

4017



x4

3989



x8

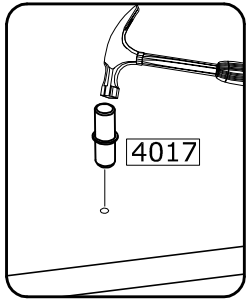

x2

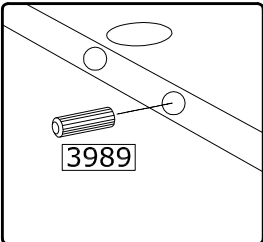
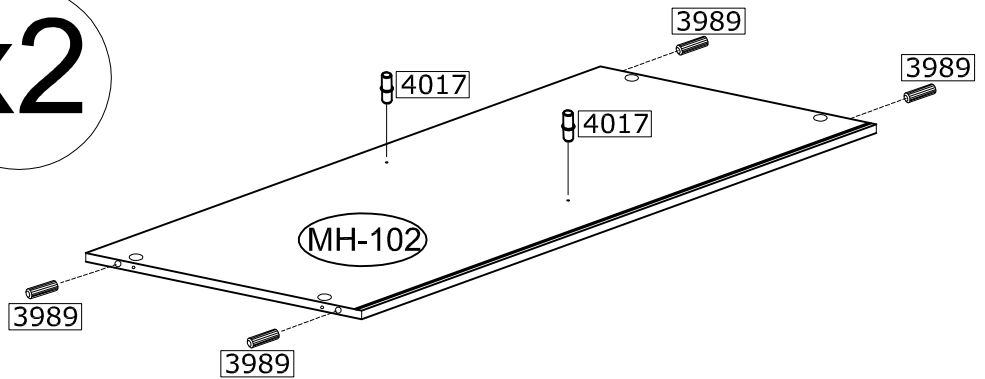

# 4

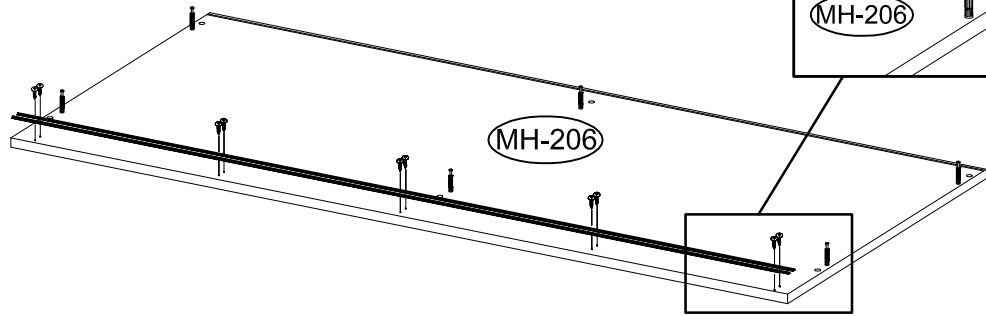
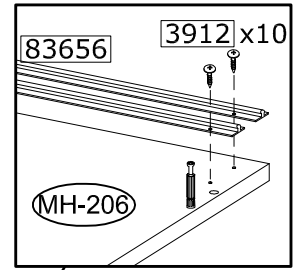
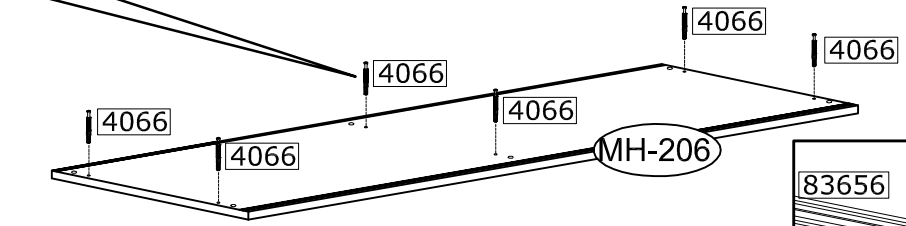
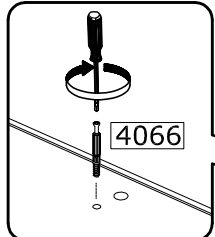
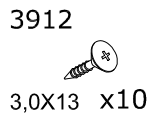
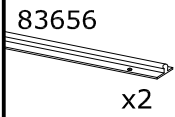

# 5

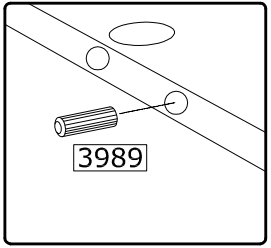
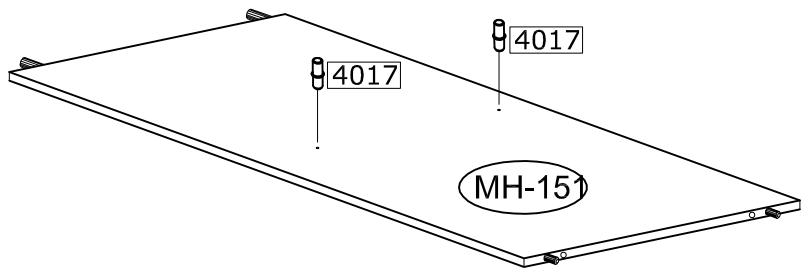
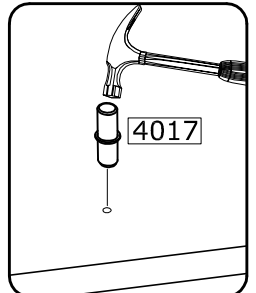
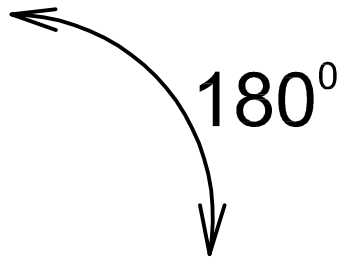
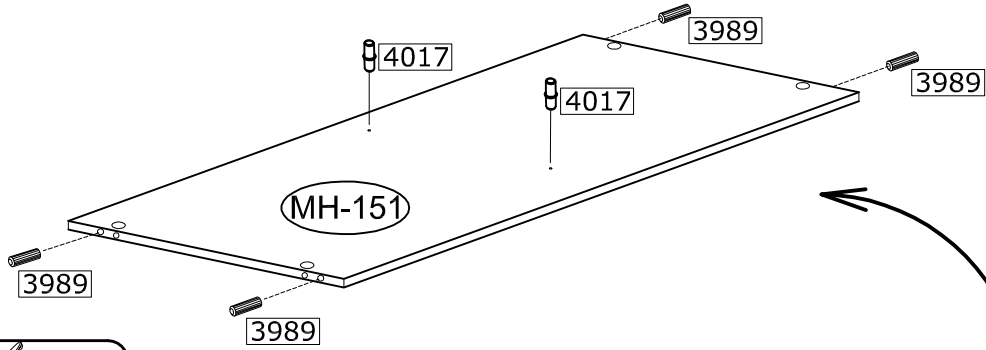
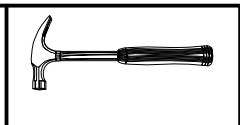
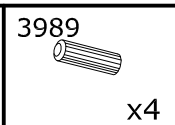
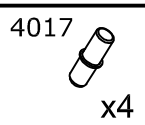

# 6

3996  
x6

136236  
x6

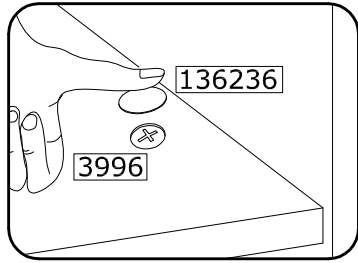
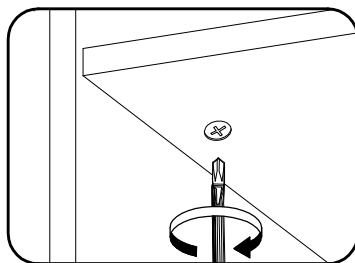
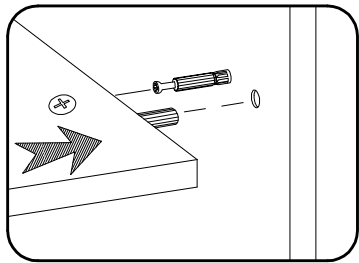
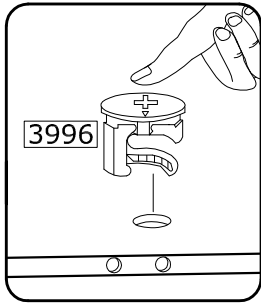
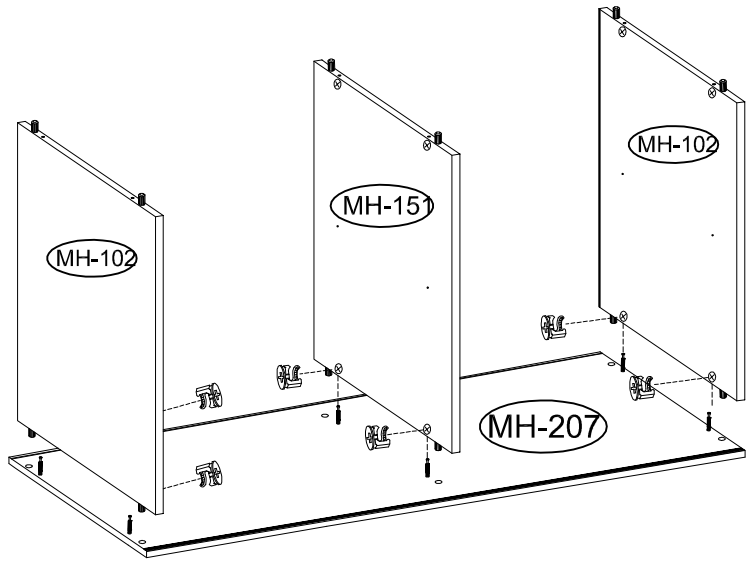

# 7

IN00378  
x1

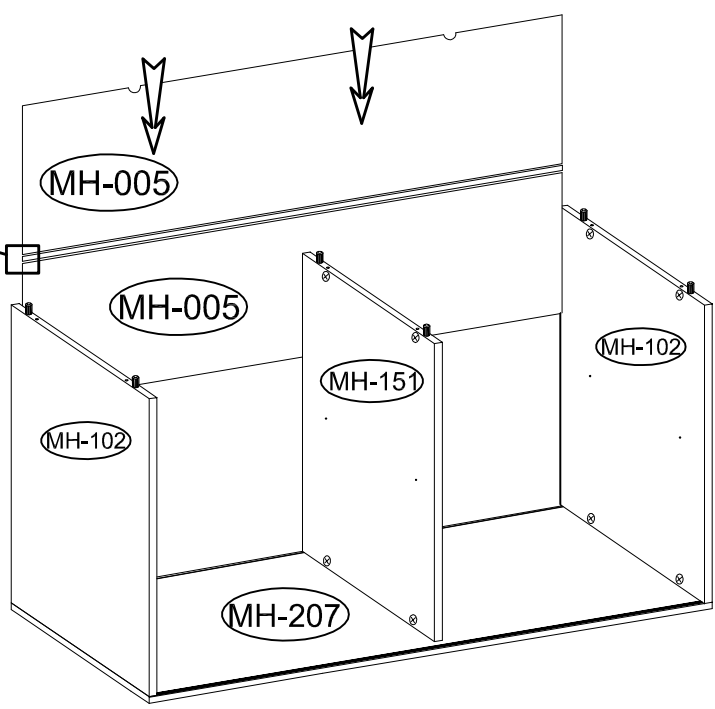
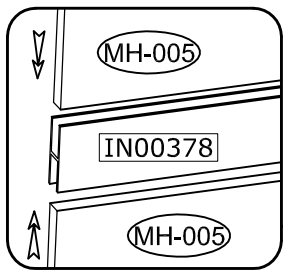

# 8

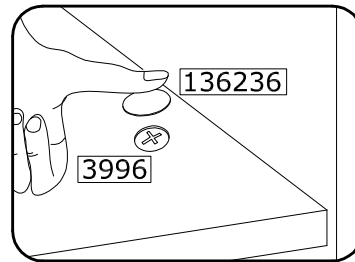
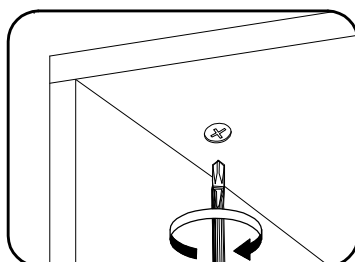
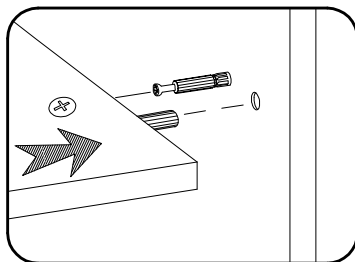
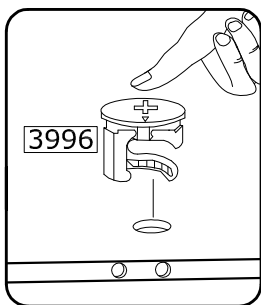
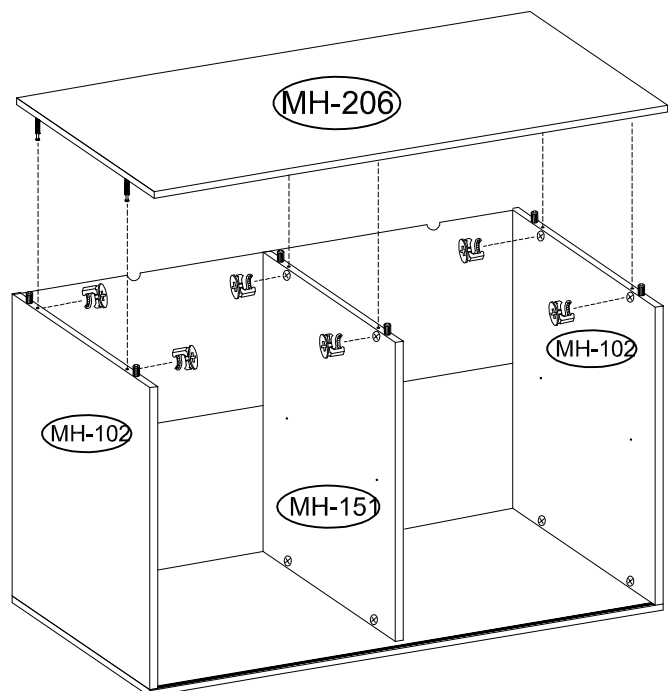
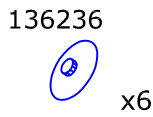

# 9

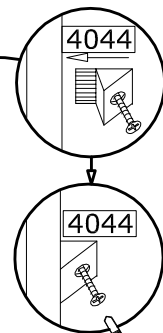
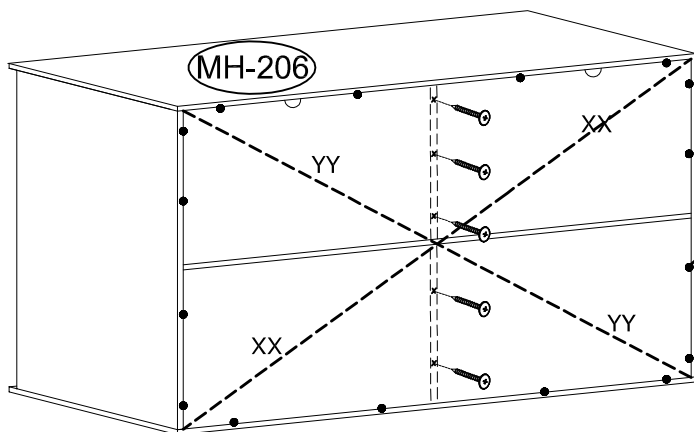
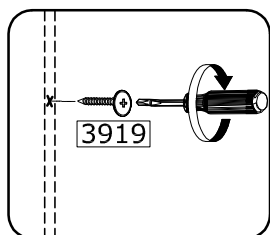
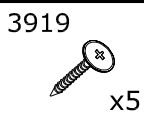
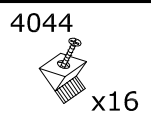





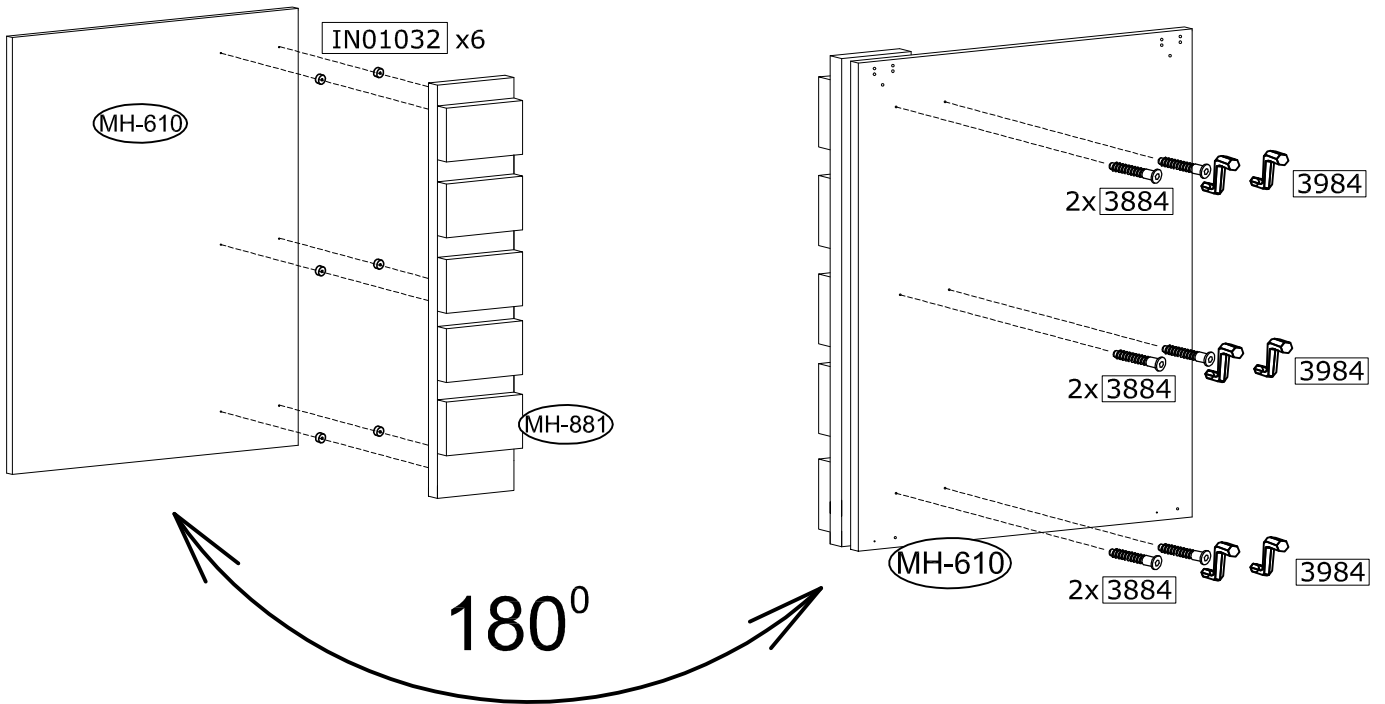

# 10

IN01032  x6	3884  x6	3984  x1		
---	--	--	--	--





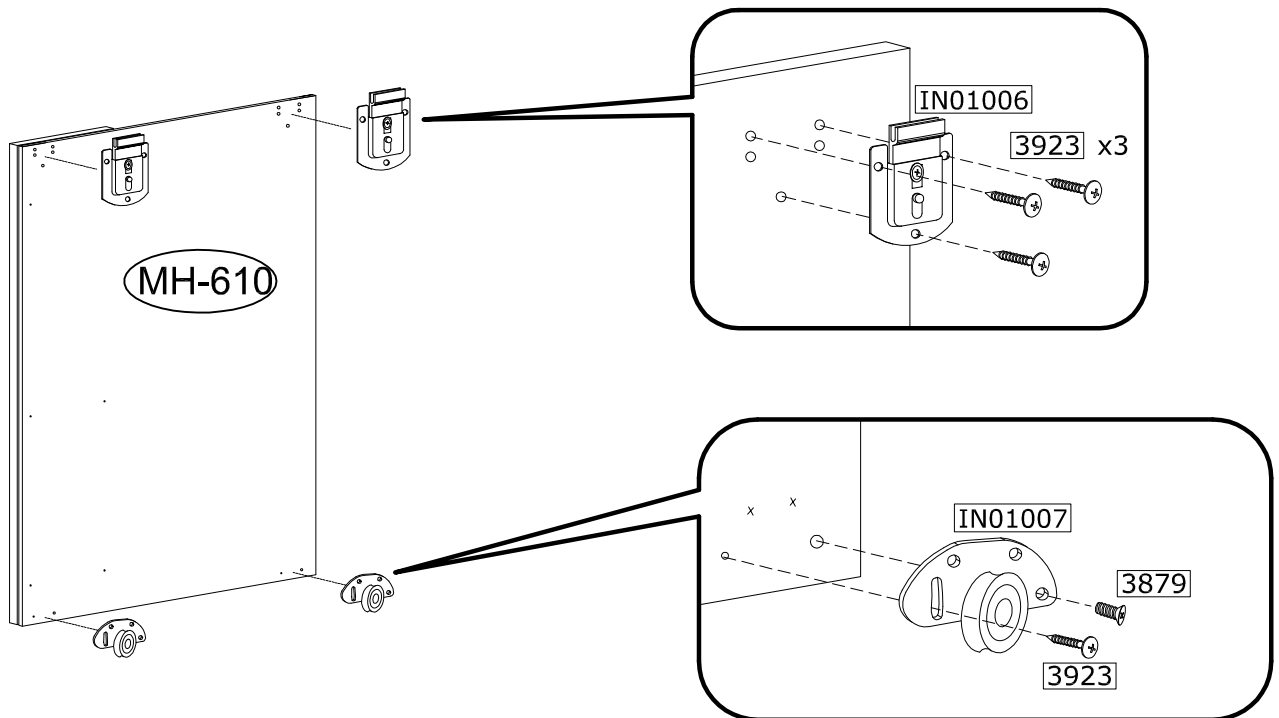

# 11

IN01006  x2	IN01007  x2	3923  x8	3879  x2	
--	--	---	---	---



# 12

IN01006  x2	IN01007  x2	3923  x8	3879  x4		
---	---	--	--	--	--

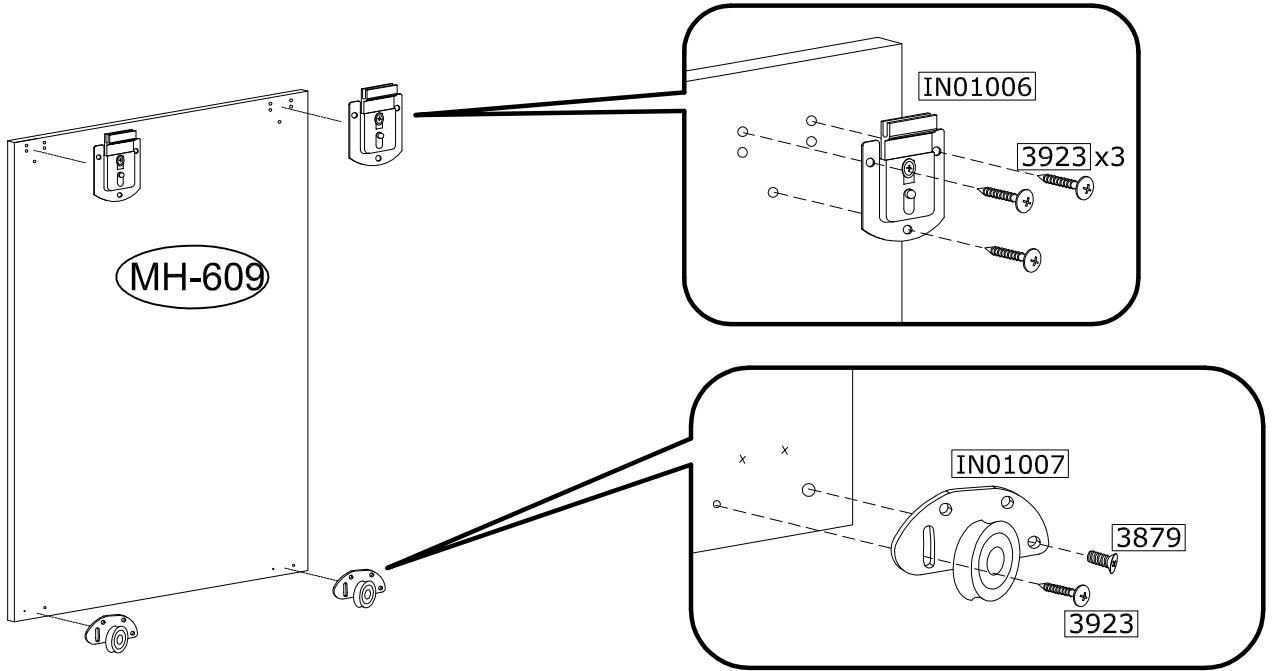

# 13

IN01112  x1		
--	--	---

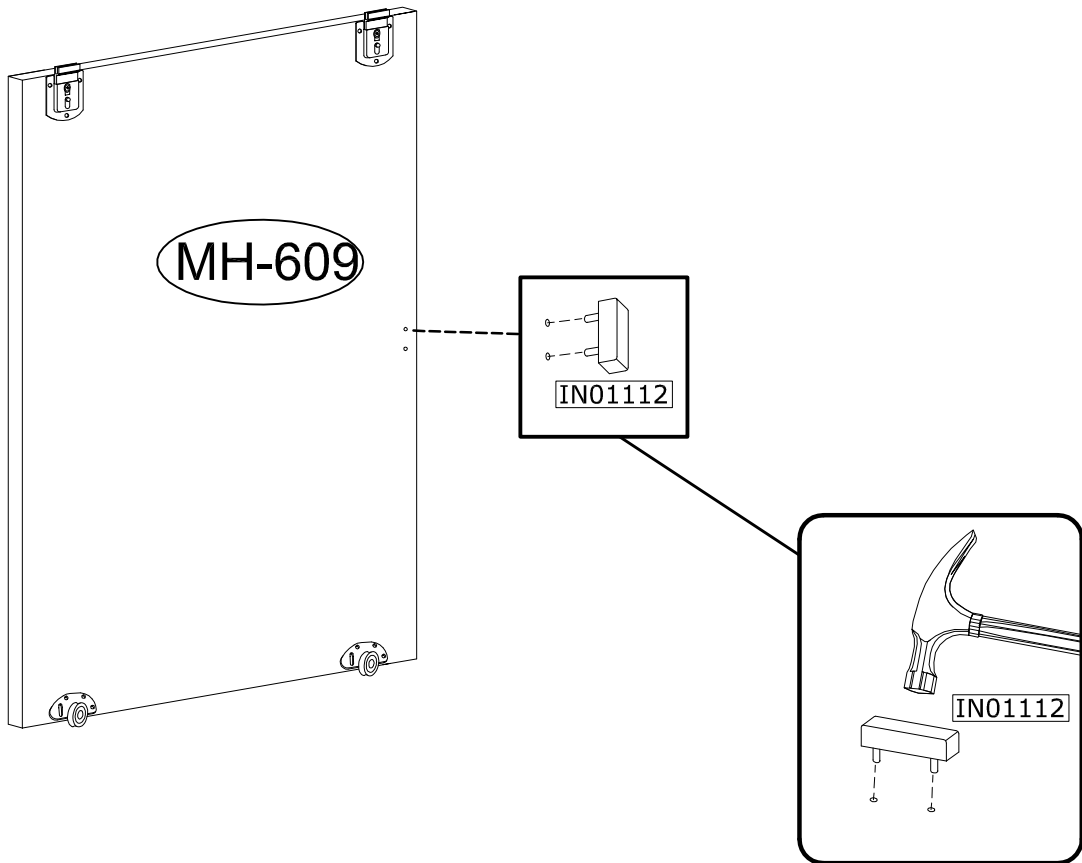

# 14

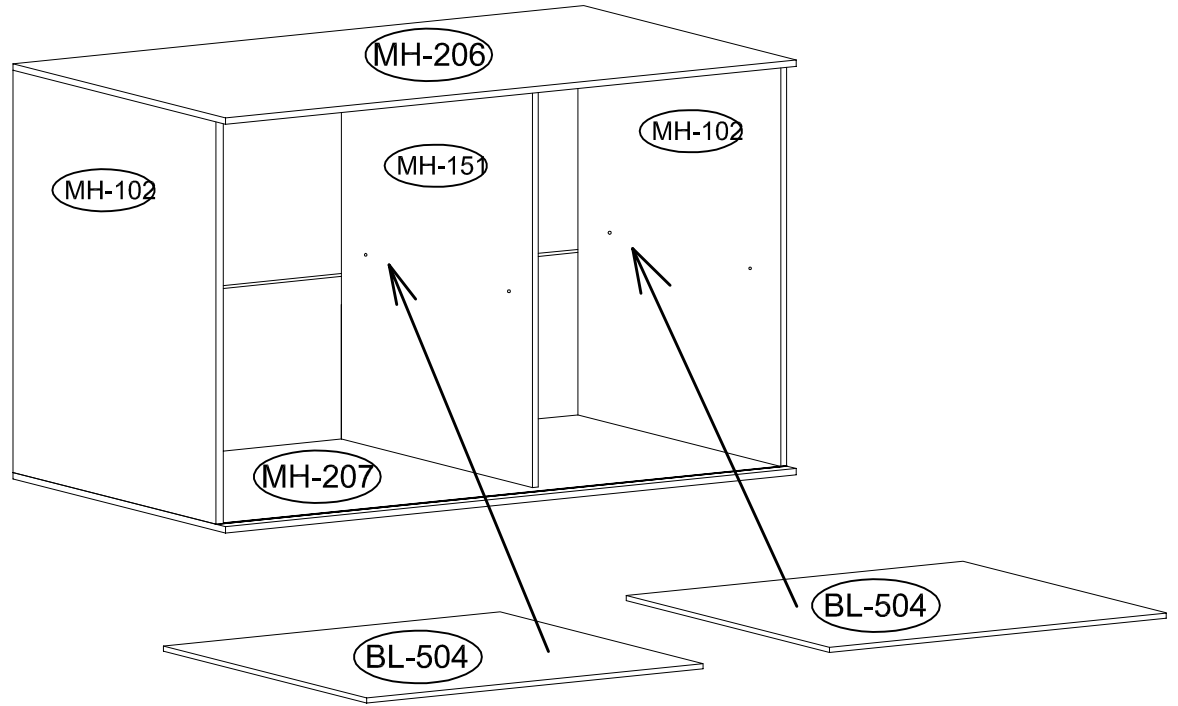

# 15

3923



x8

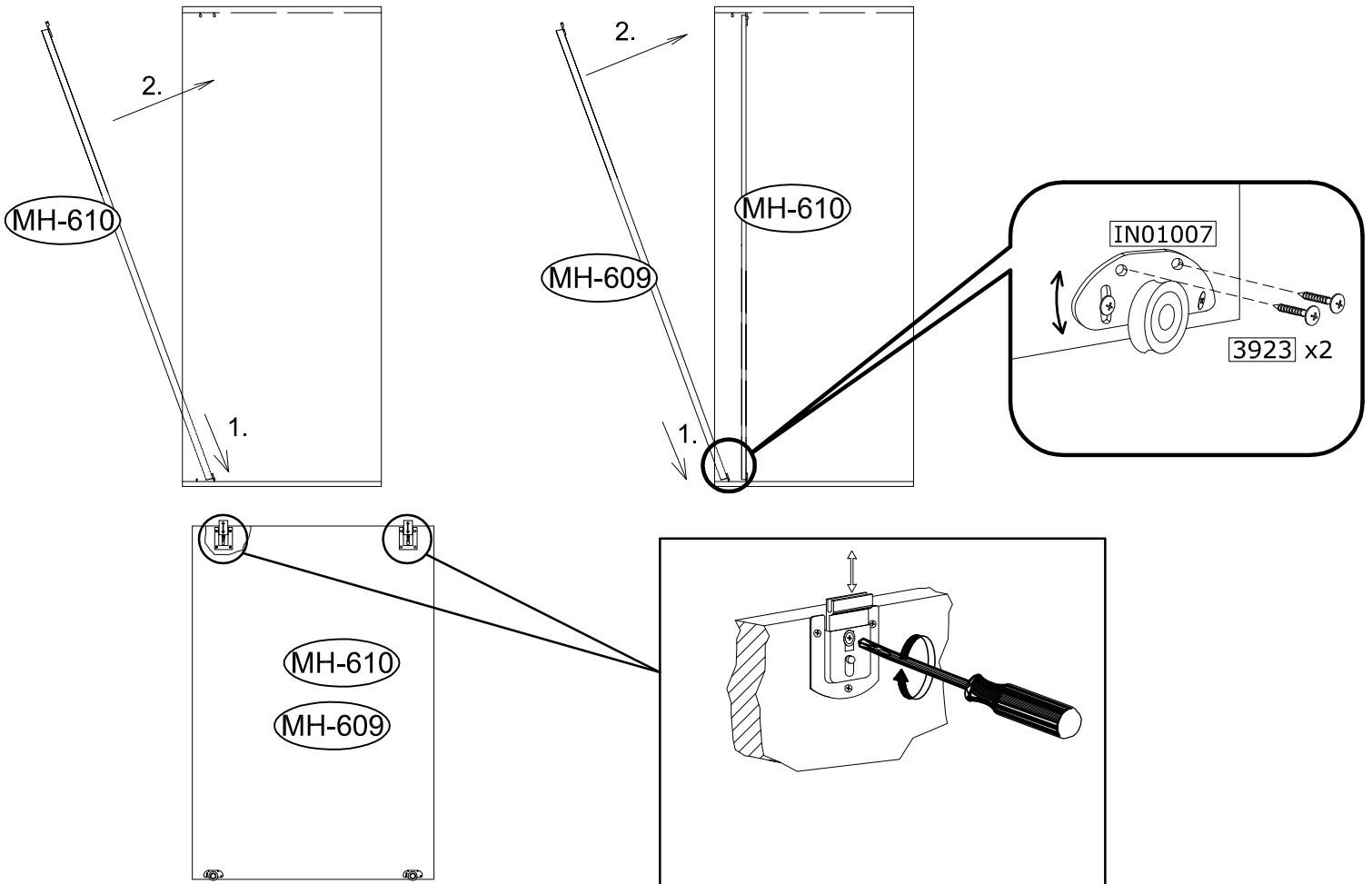

# 16

71900  
x2

3923  
x4

