

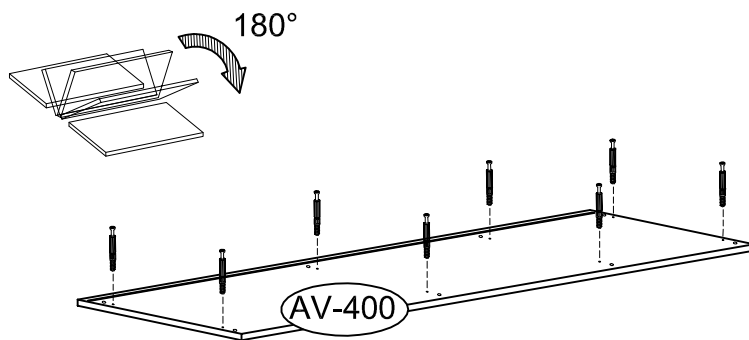

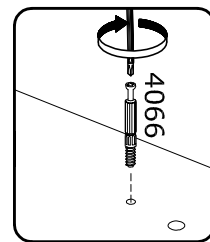

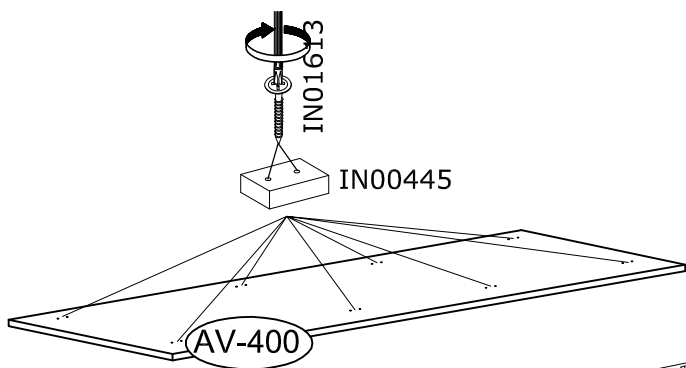

1

4066  x8	IN01613  x16	IN00445  x8		
--	--	---	--	---







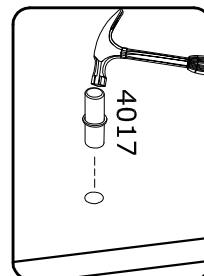
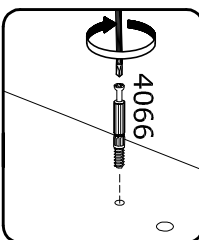
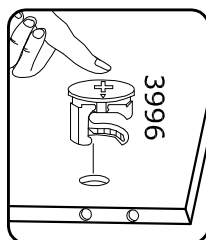
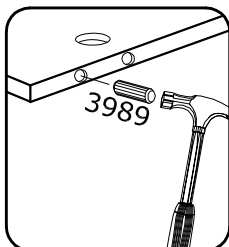
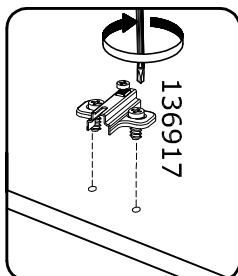
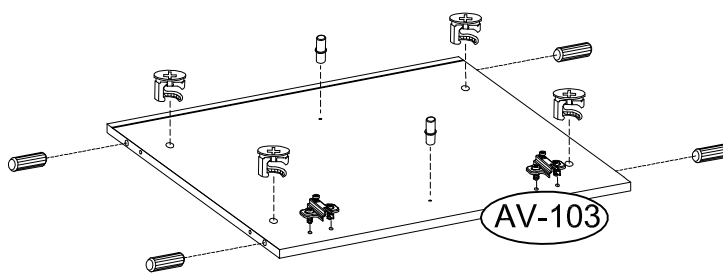
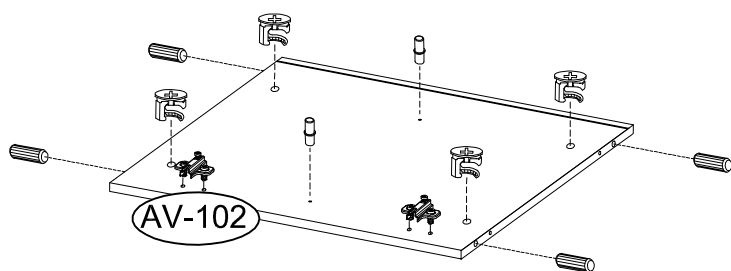

2

3996  x8	3989  x8	4017  x4	136917  x4	
---	---	---	---	---



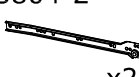



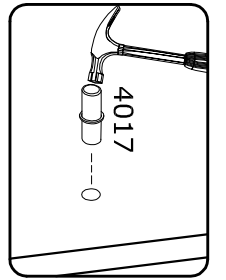
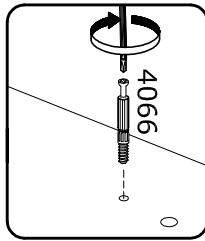
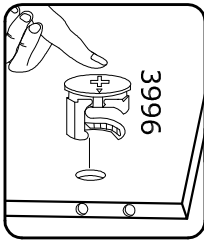
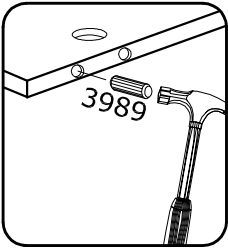
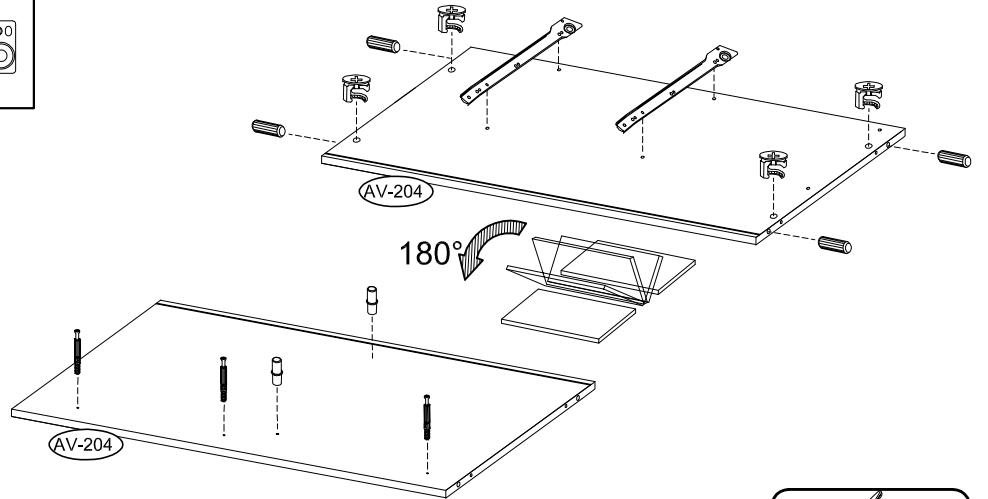
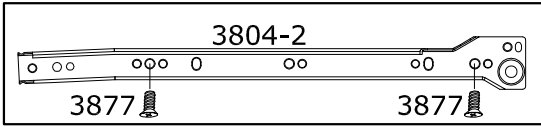

3

4066  x3	3996  x4	3989  x4	4017  x2	3804-2  x2	3877  x4	
--	--	--	--	--	--	--

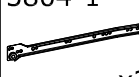

4

4066  x3	3996  x4	3989  x4	4017  x2	3804-1  x2	3877  x4	
---	---	---	---	---	---	--

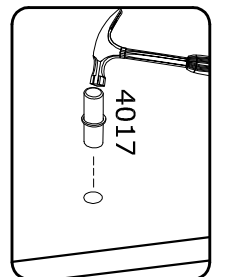
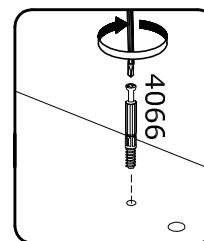
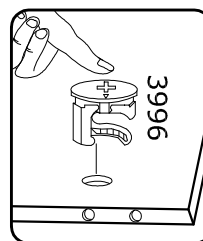
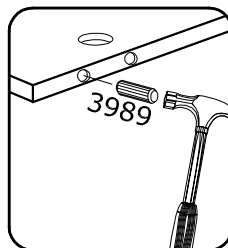
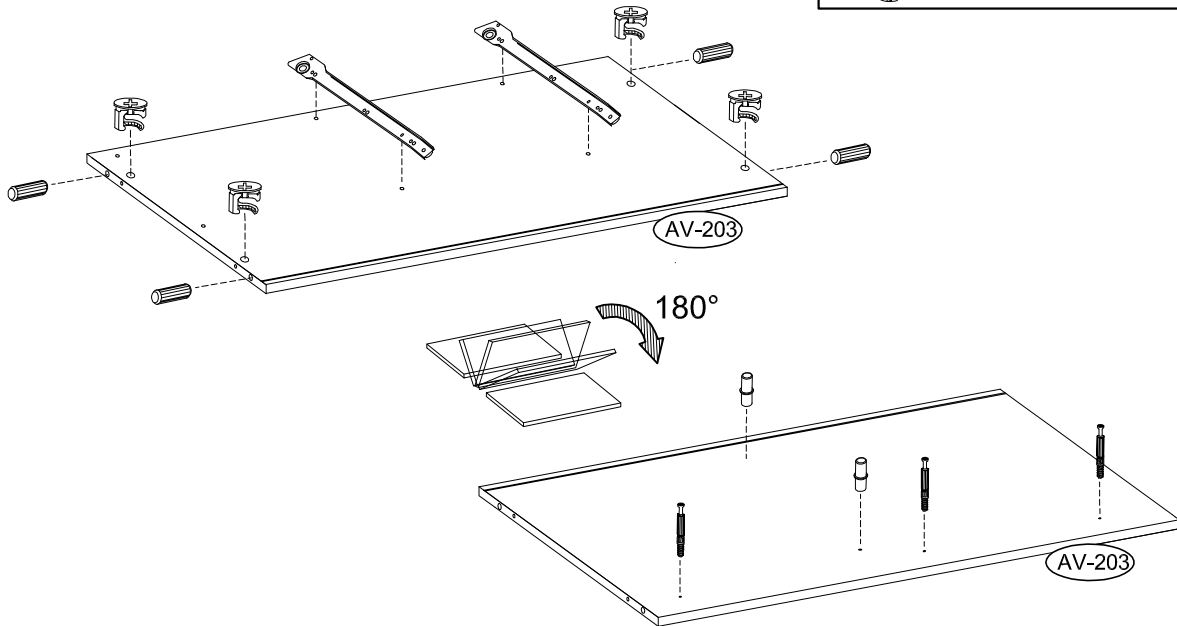
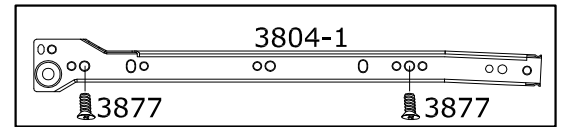

5

4066



x6

3996



x12



x2

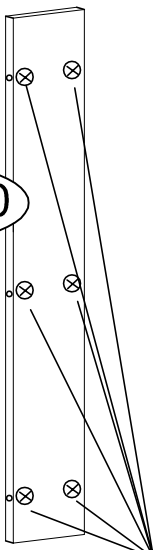

AV-850

x2

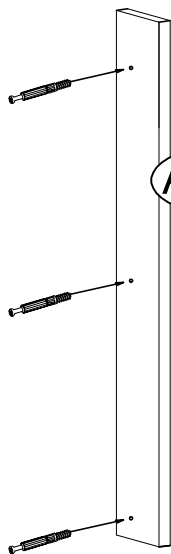

AV-851

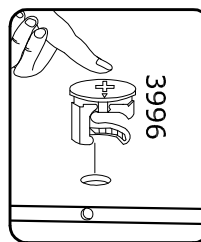

3996

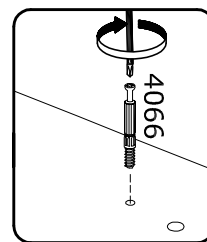

4066

6



x2

AV-850

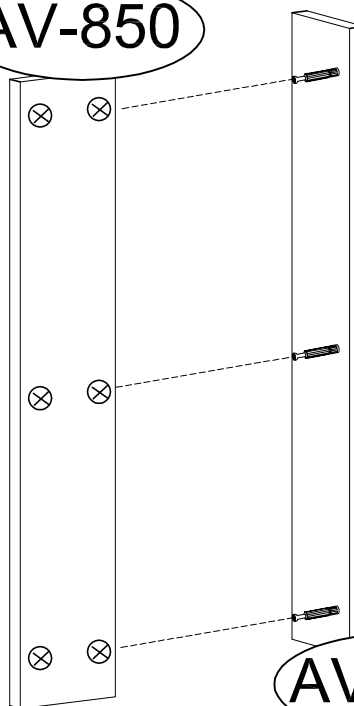

AV-851

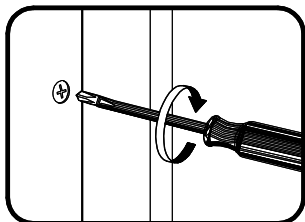
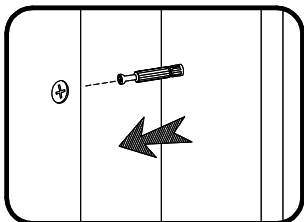

7

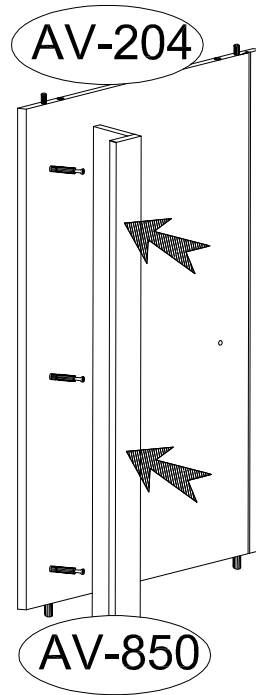
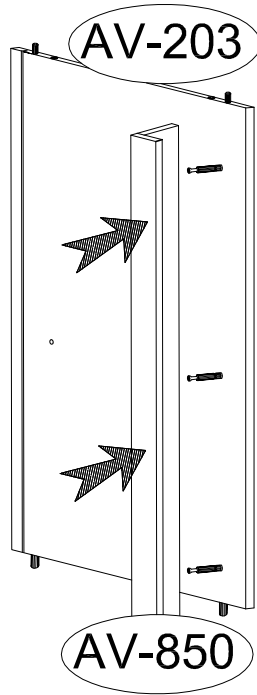
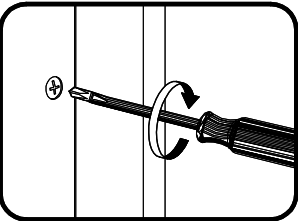
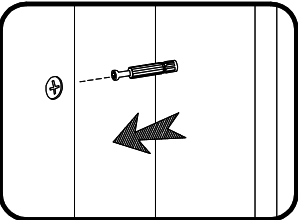

8

3989 x6	IN01157 x12	3918 x12	4066 x12	3804-3 x3	3804-4 x3	3996 x12	
136239 x12							

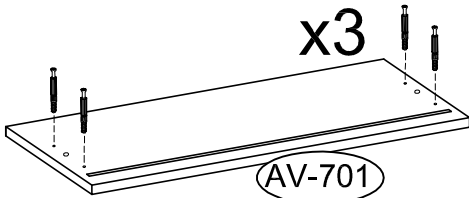

x3

AV-701

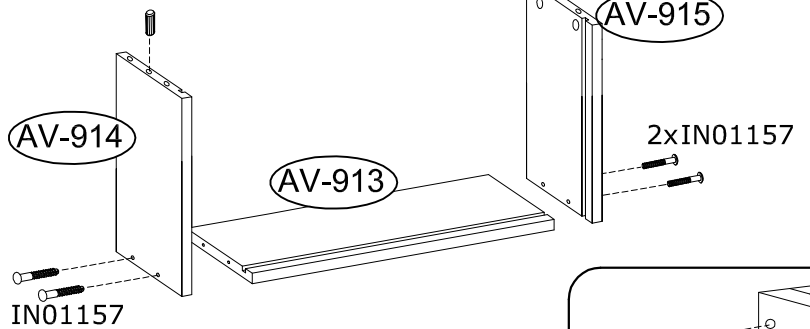

AV-914

AV-913

AV-915

2xIN01157

IN01157

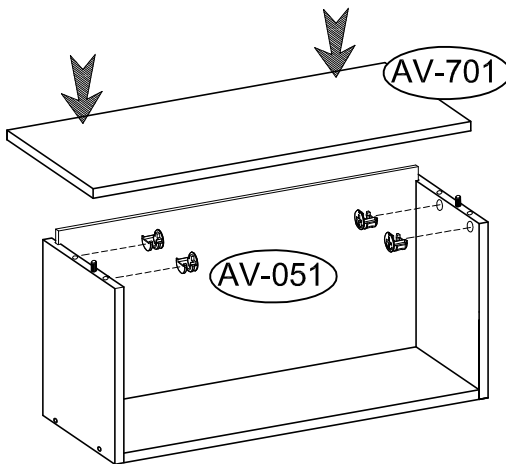

AV-701

AV-051

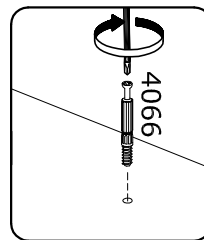

4066

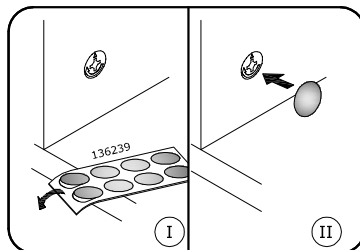
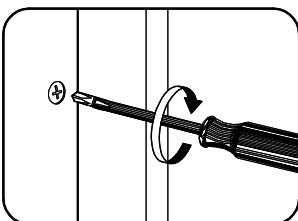
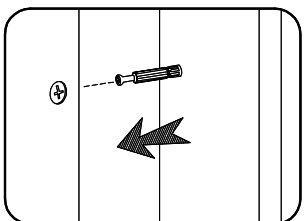
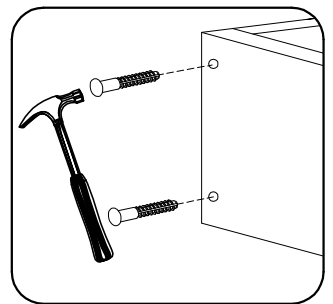

I

II

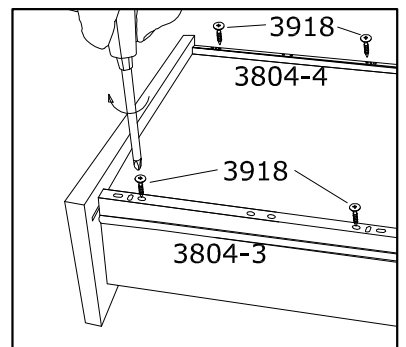
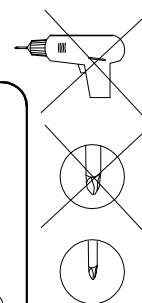

3918

3804-4

3918

3804-3

9

136858

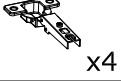

x4

3879



x8

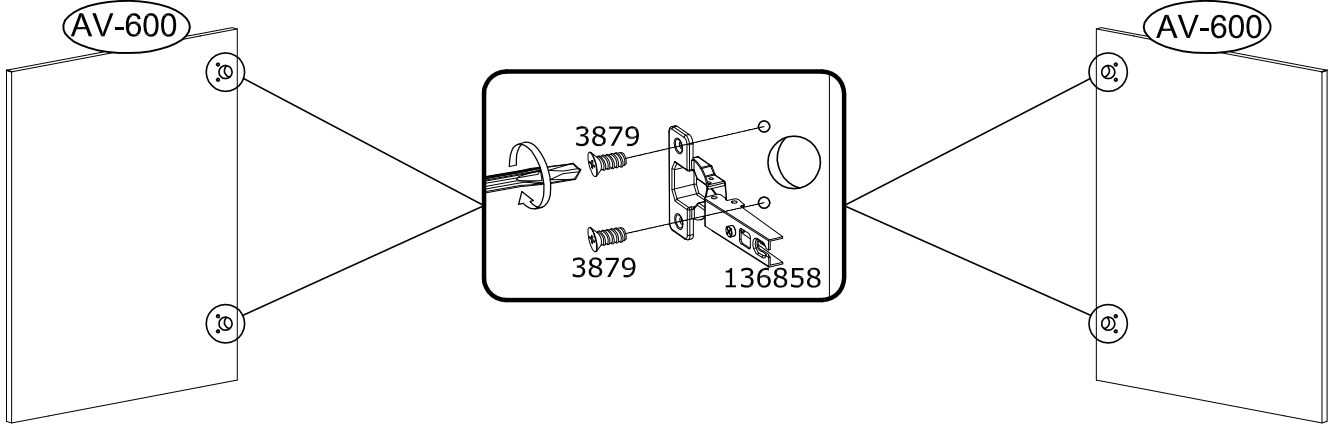

10

4066



x12

3996



x4

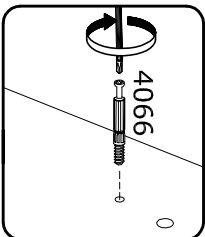
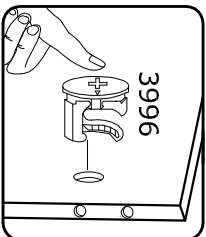
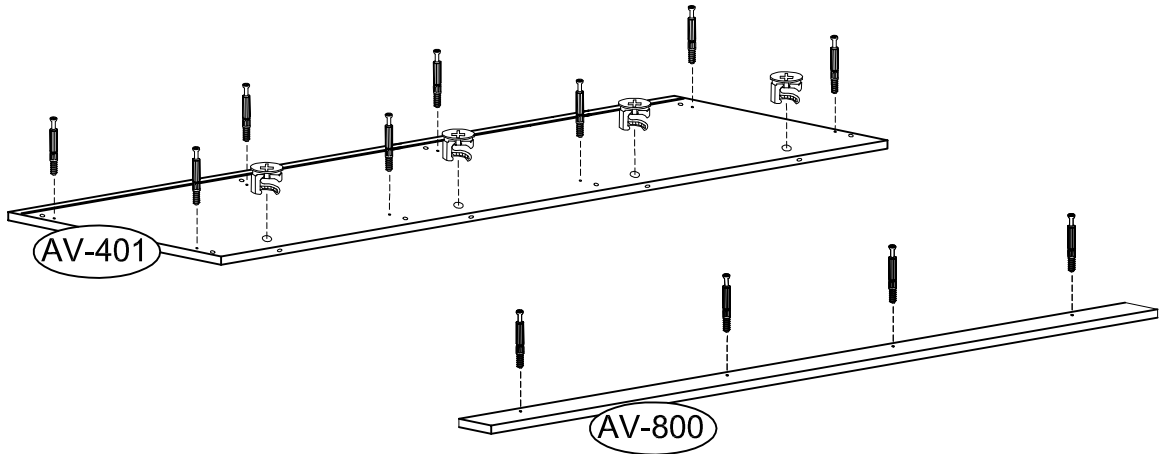

11

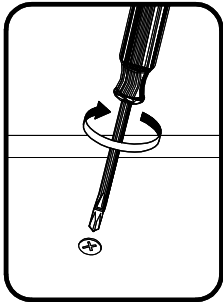
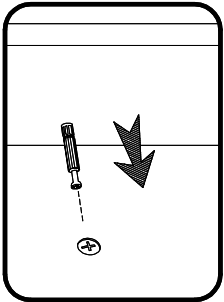
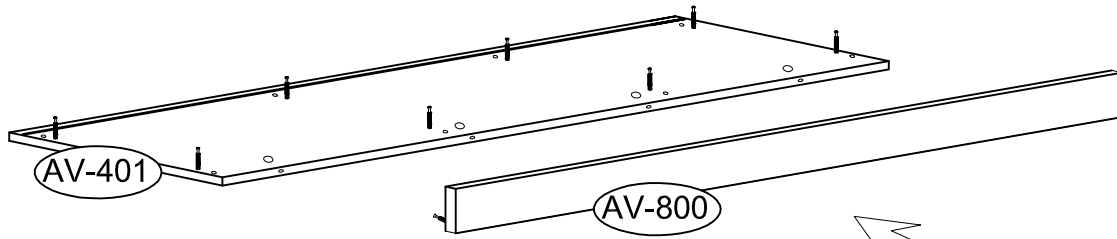

12

136239

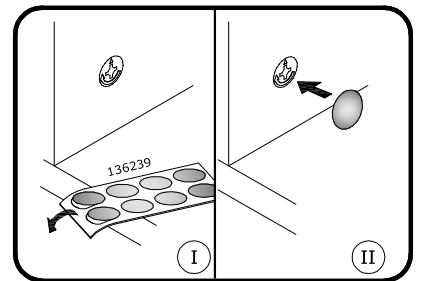
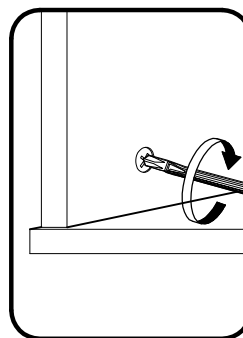
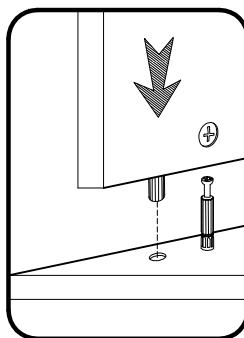
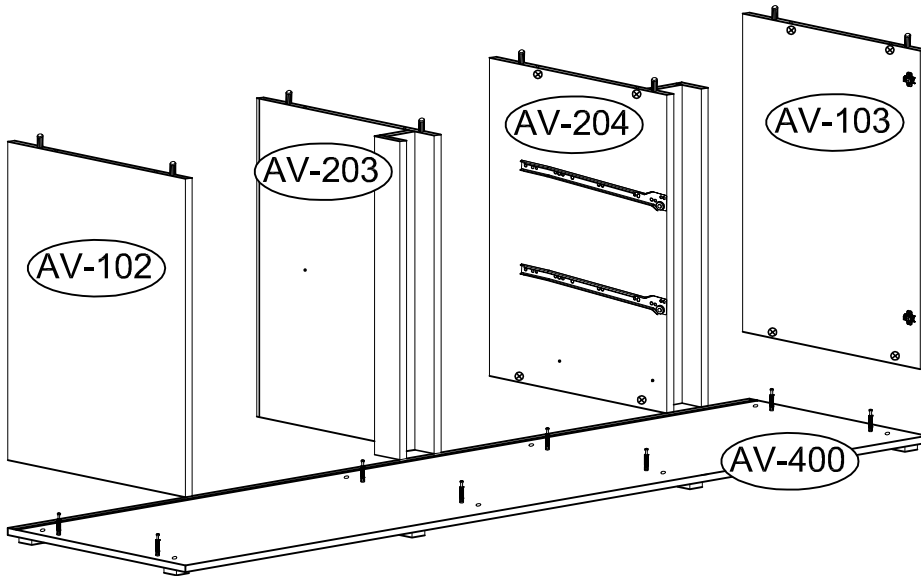

13

136239



x4

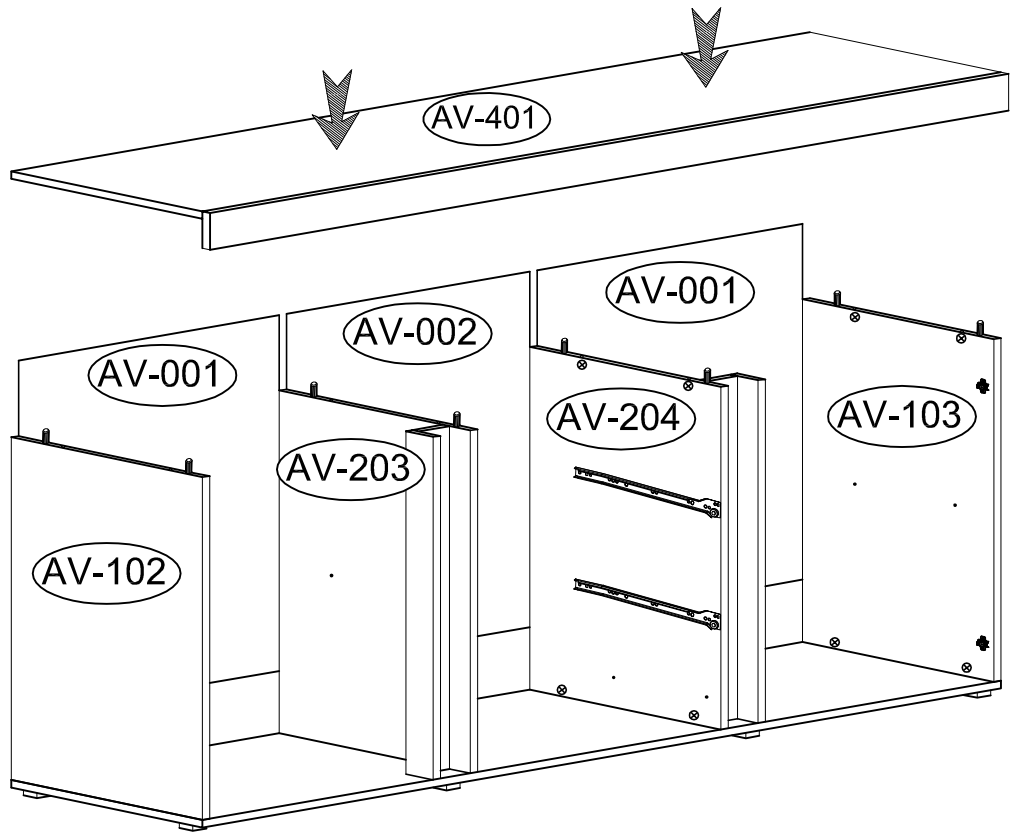
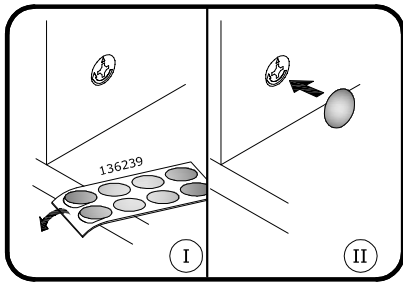
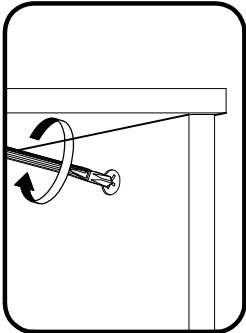
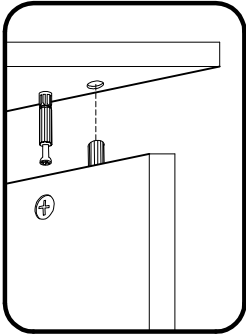

14

4044



x18

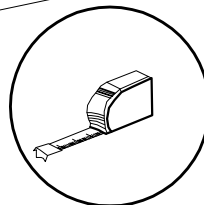
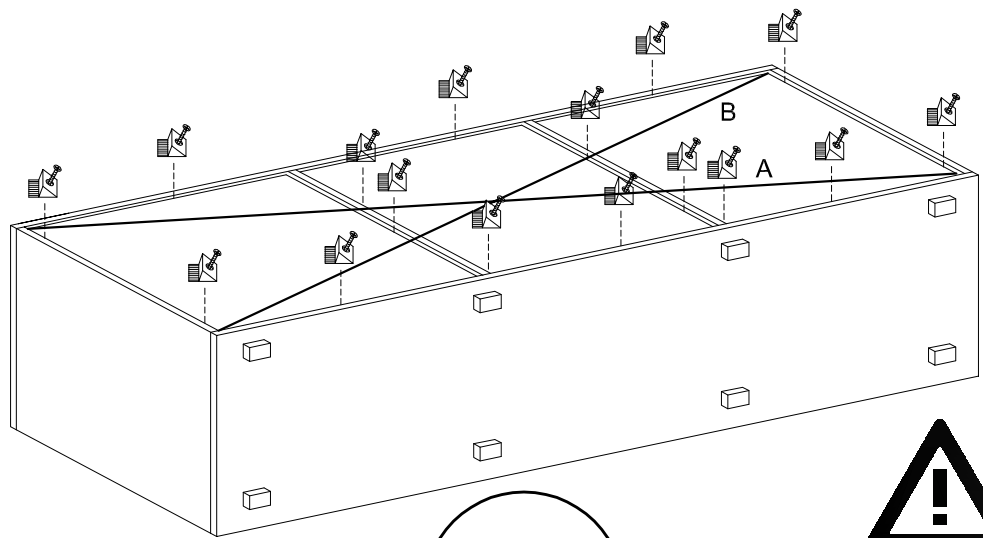
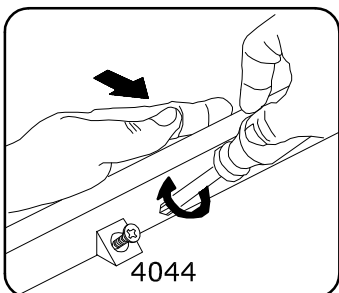
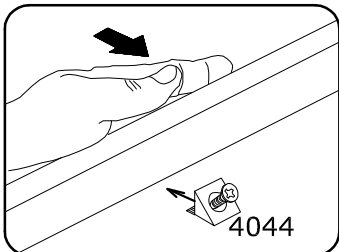

15

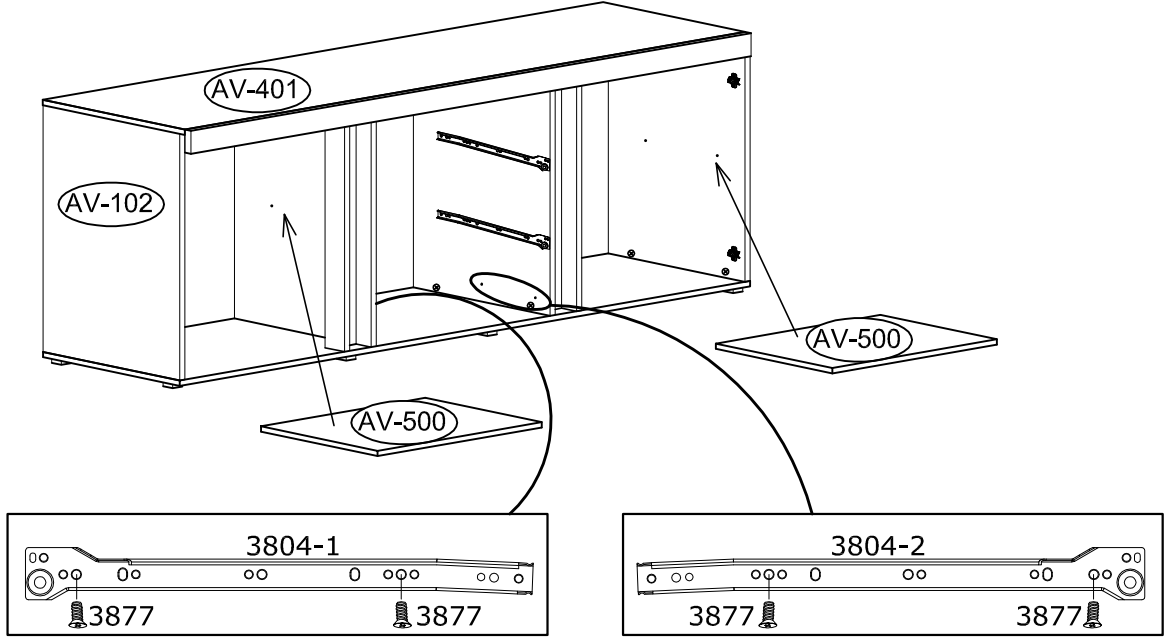
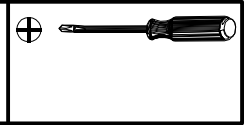
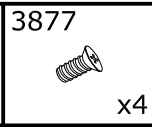
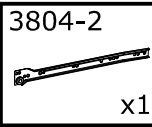
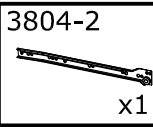

16

