

F-1	1531	395	16	x1	1/2
F-2	1531	395	16	x1	1/2
F-3	352	394	16	x1	1/2
F-4	352	394	16	x1	1/2
F-5	352	345	16	x1	1/2
F-6	352	345	16	x1	1/2
F-7	482	335	16	x1	1/2
F-8	346	496	16	x1	1/2
F-9	346	496	16	x1	1/2
F-10	1512	366	3	x1	1/2

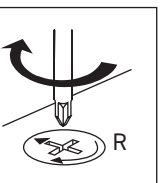

1

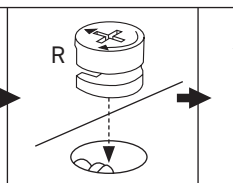
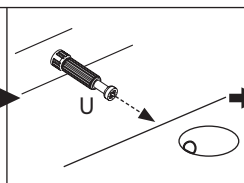
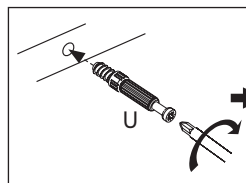
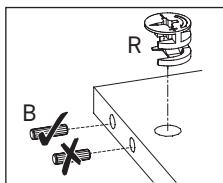
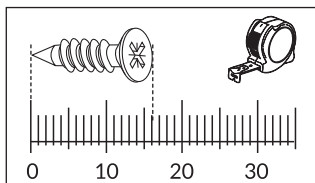
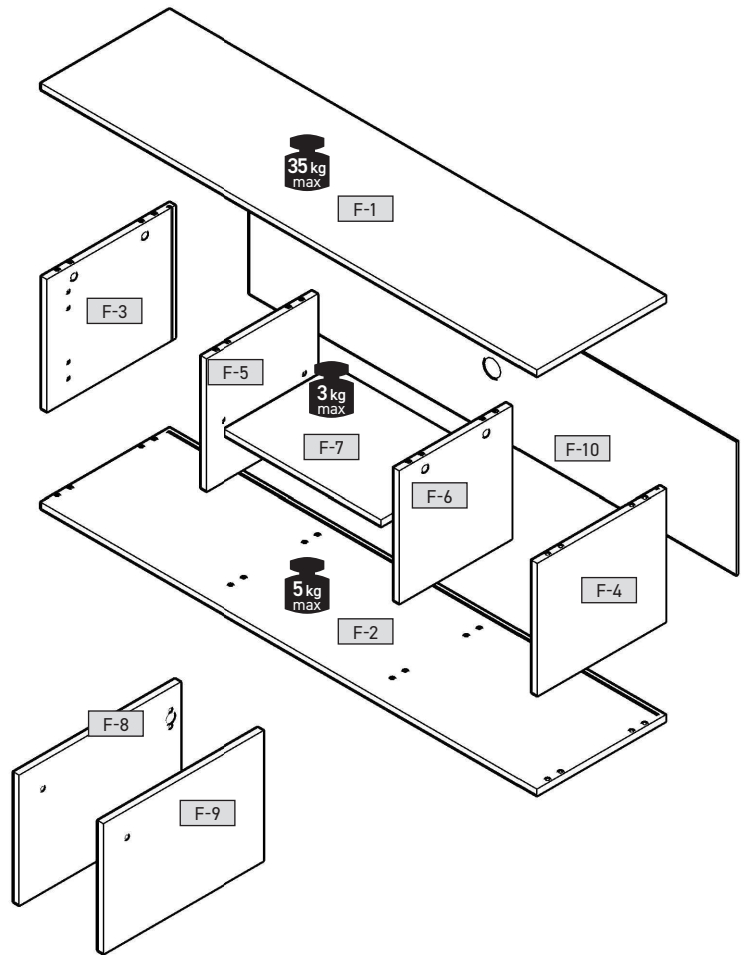
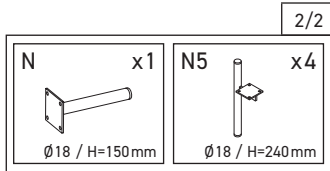
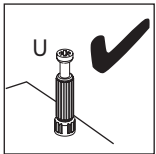
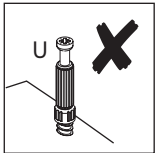
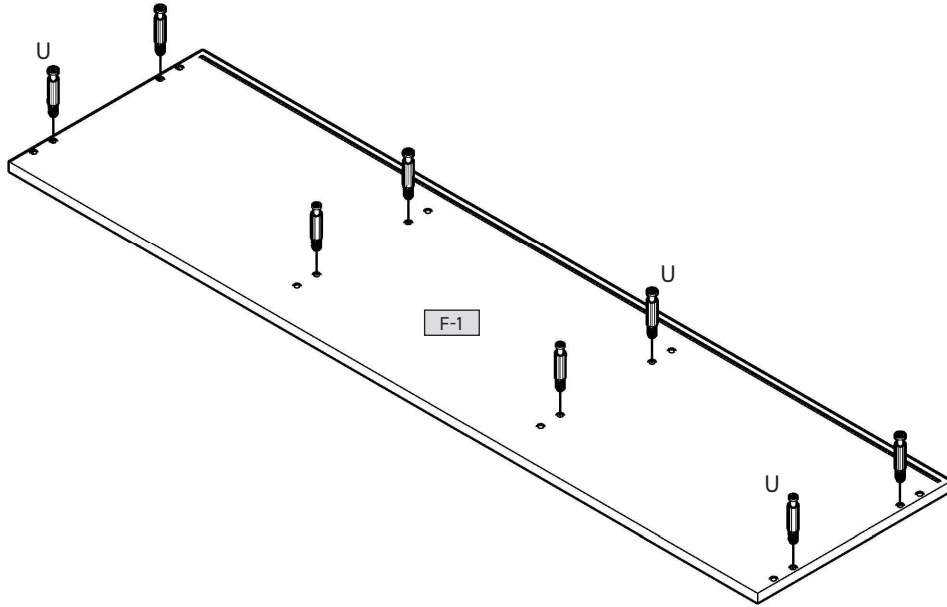
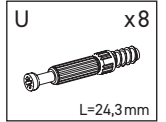

2

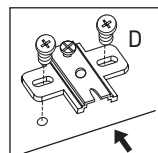
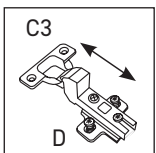
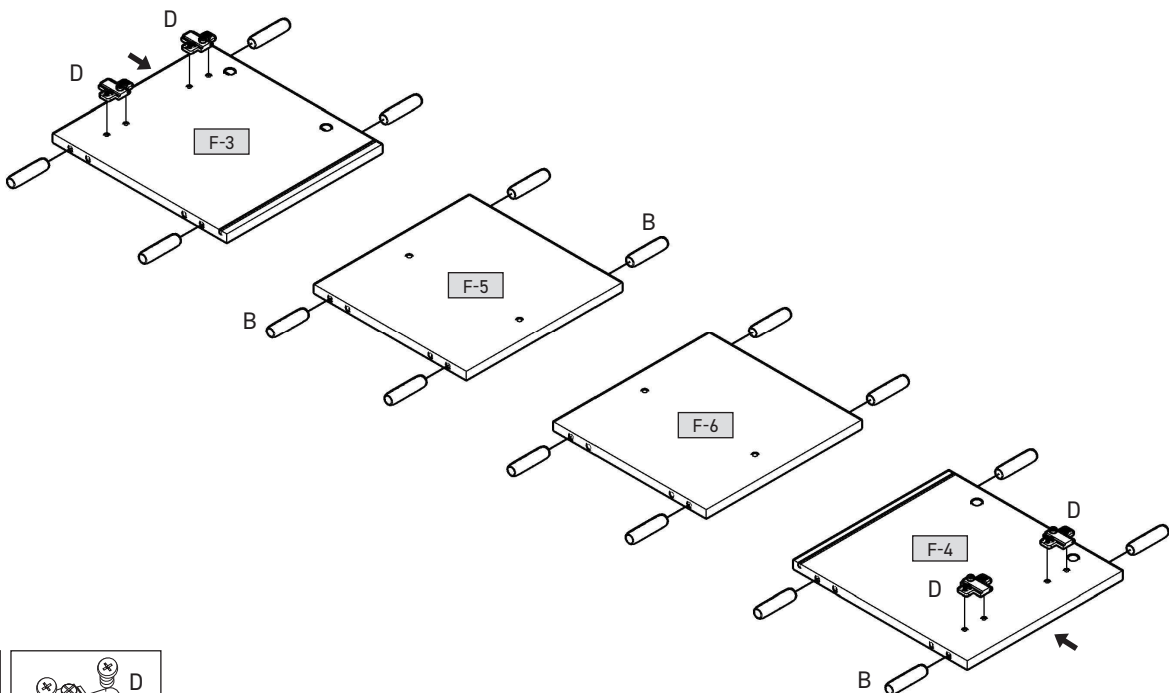
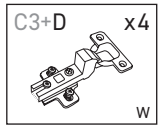
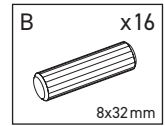

3

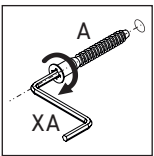
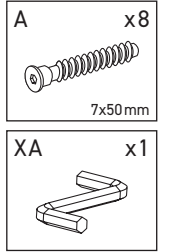
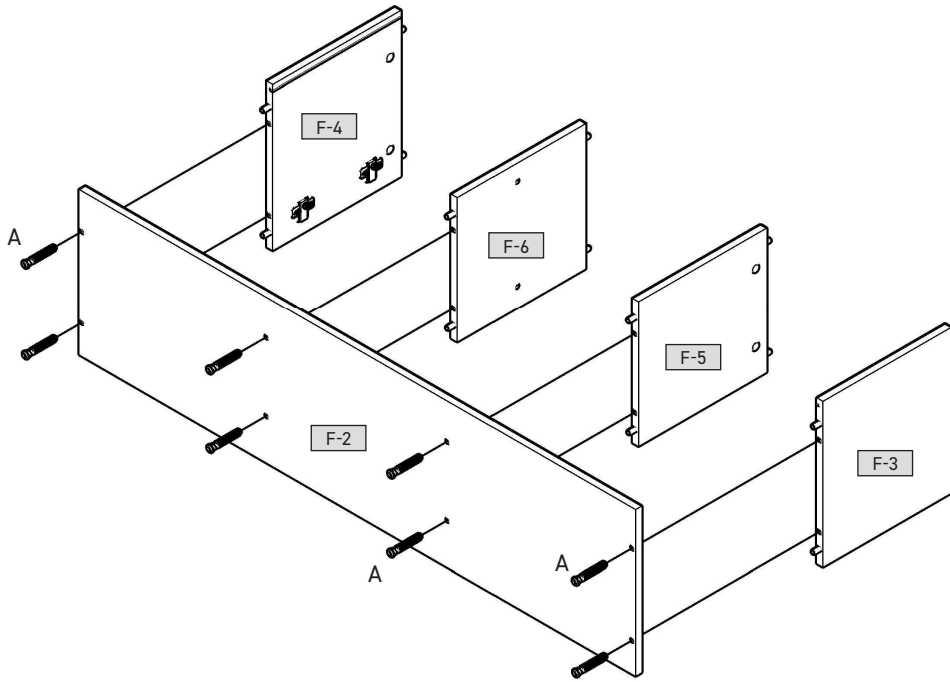

4

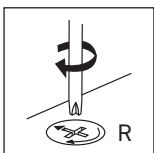
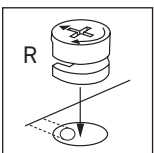
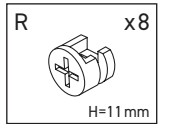
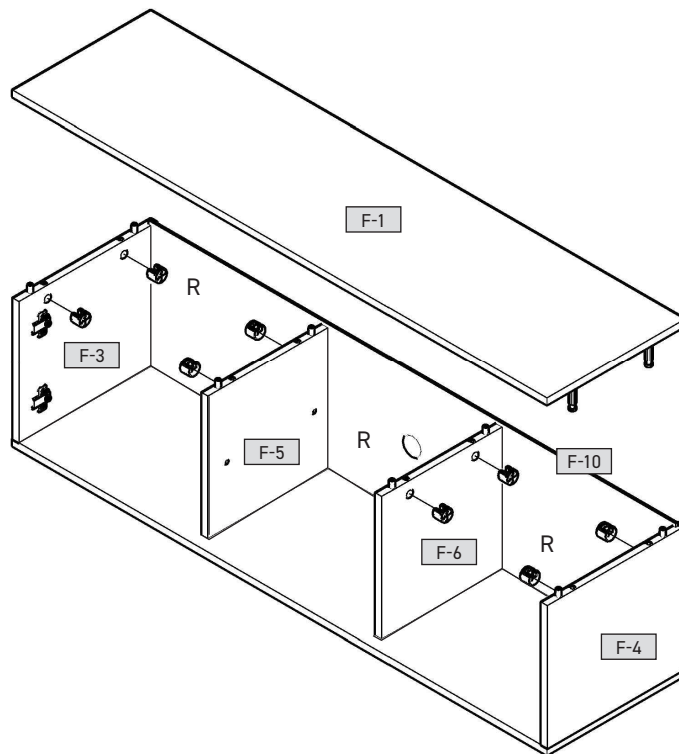

5

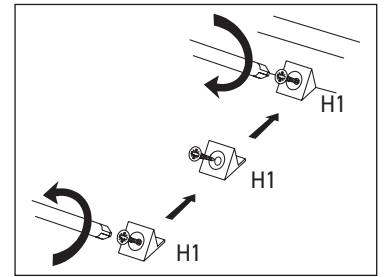
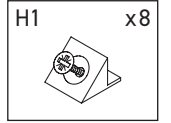
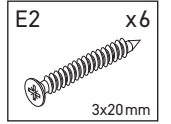
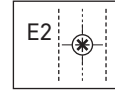
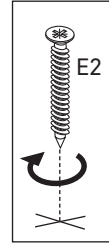
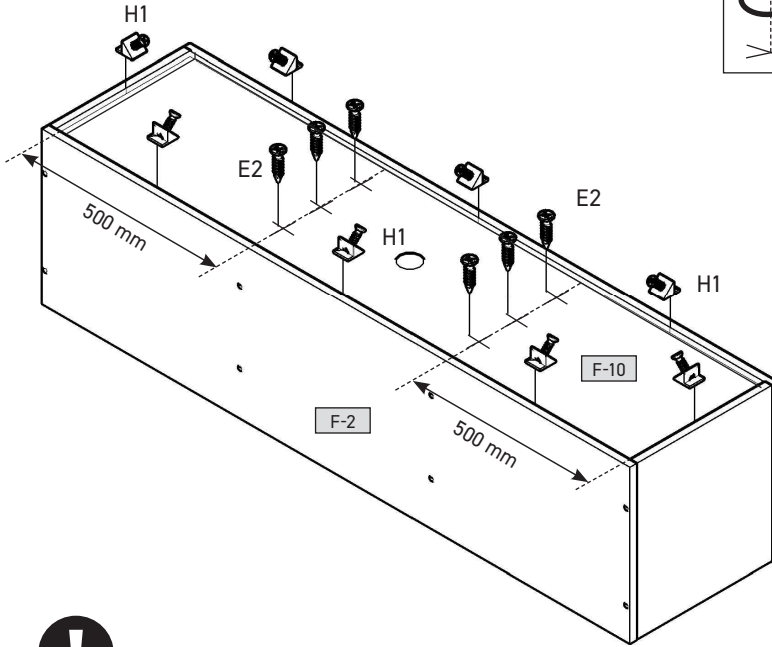
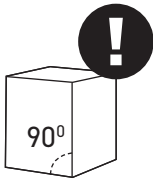
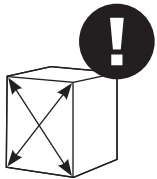

6

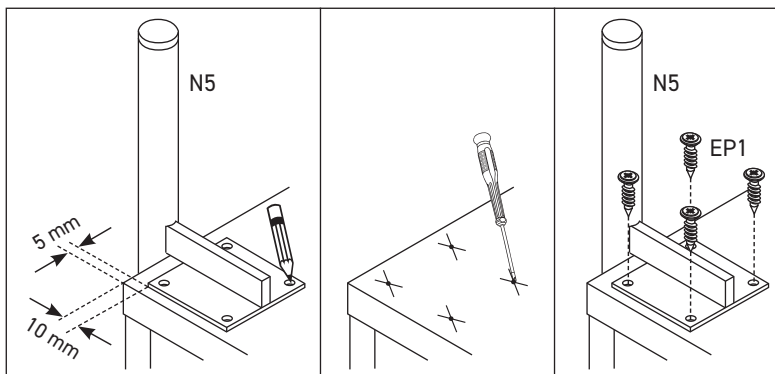
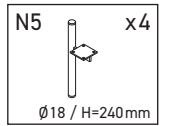
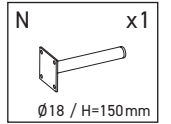
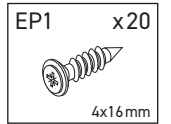
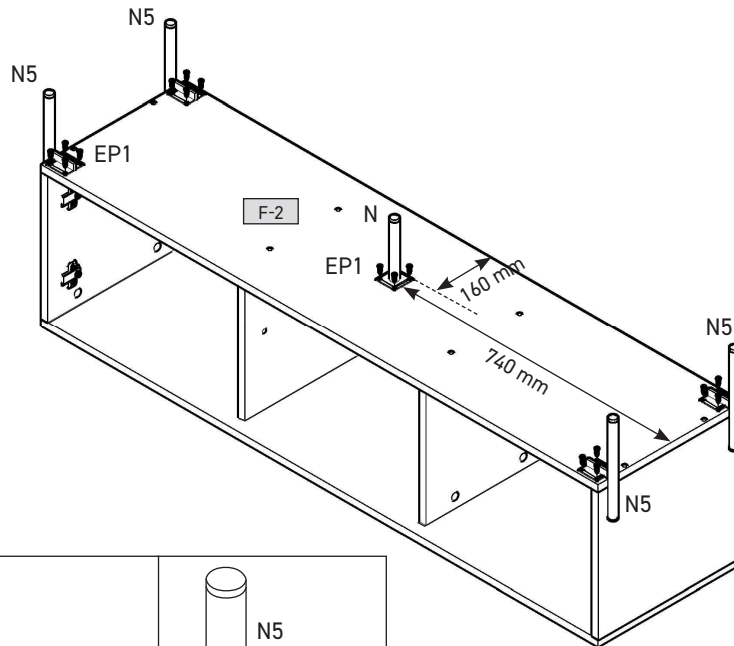

7

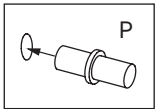
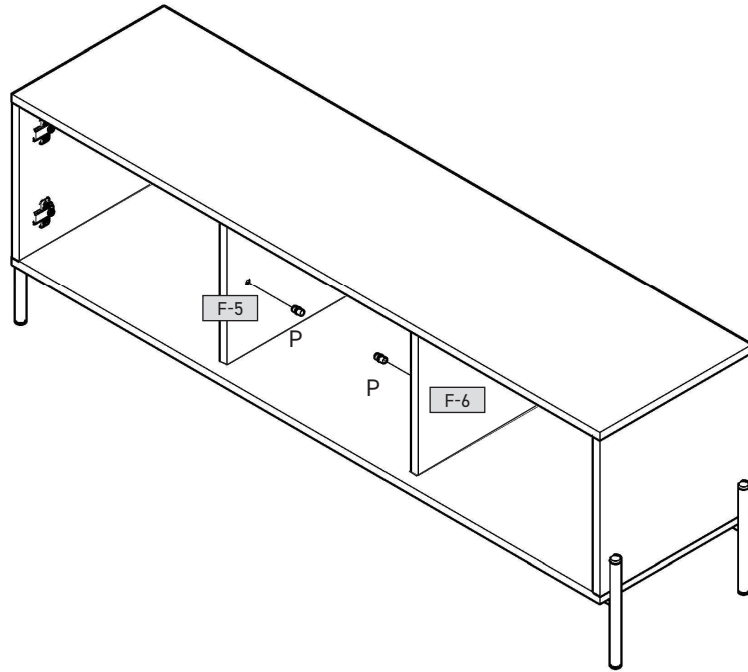
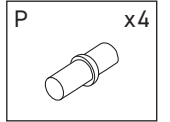
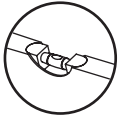

8

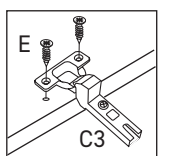
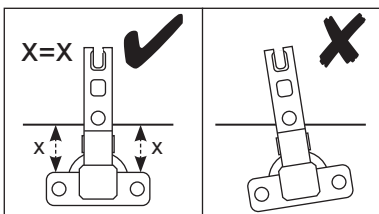
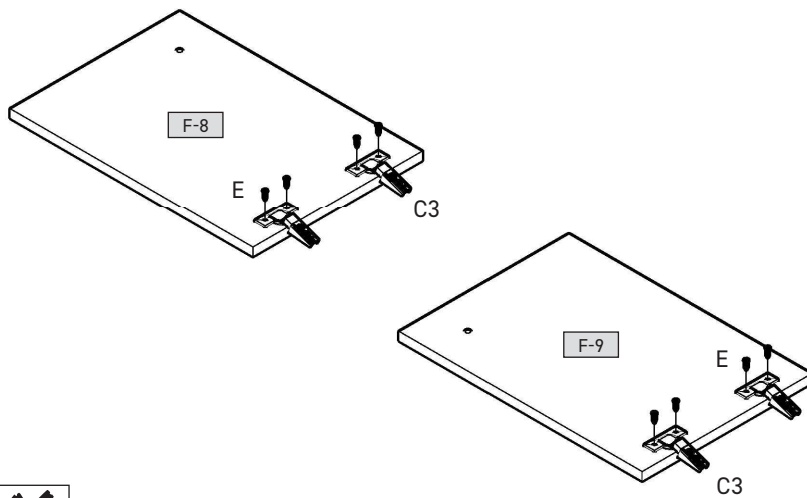
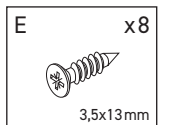
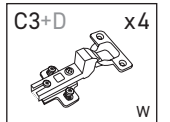

9

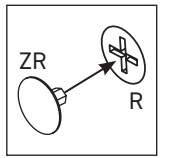
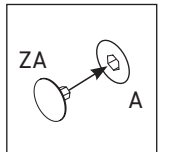
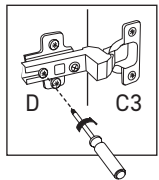
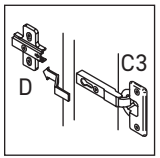
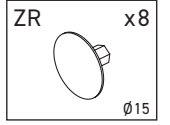
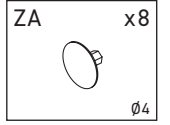
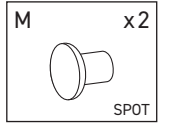
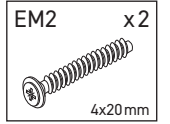
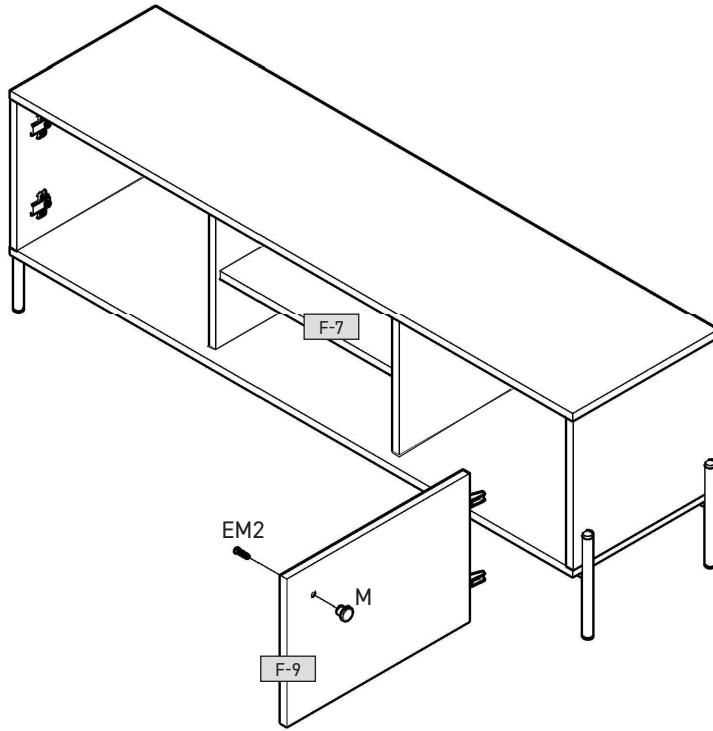
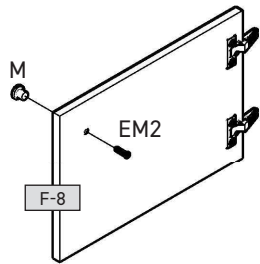

10

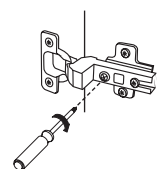
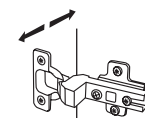
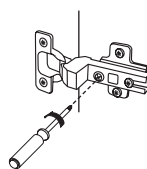
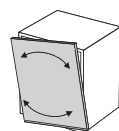
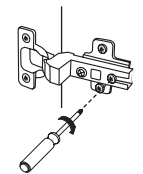
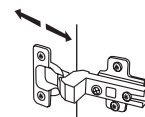
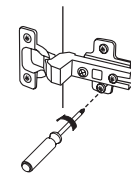
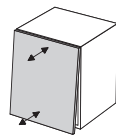
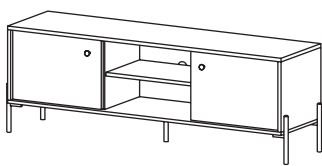
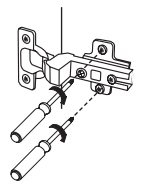
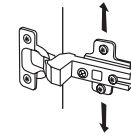
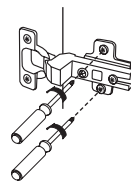
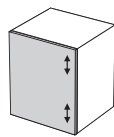



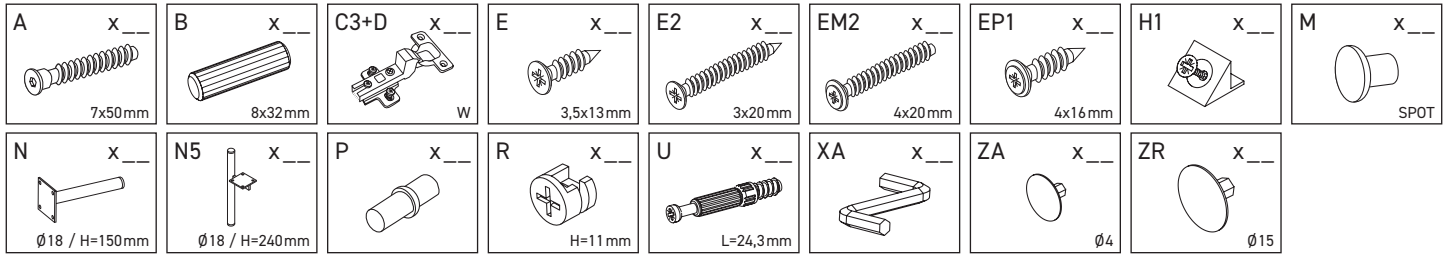

F-1	1531	395	16	x 1	1/2
F-2	1531	395	16	x 1	1/2
F-3	352	394	16	x 1	1/2
F-4	352	394	16	x 1	1/2
F-5	352	345	16	x 1	1/2
F-6	352	345	16	x 1	1/2
F-7	482	335	16	x 1	1/2
F-8	346	496	16	x 1	1/2
F-9	346	496	16	x 1	1/2
F-10	1512	366	3	x 1	1/2

