

2023-09-15

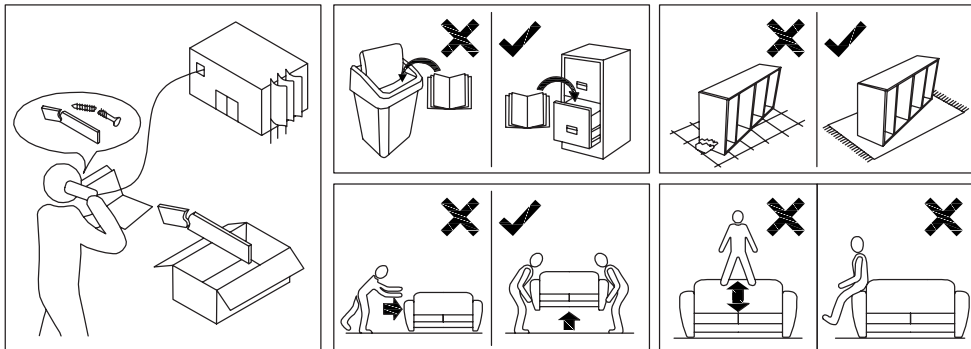

45 min.





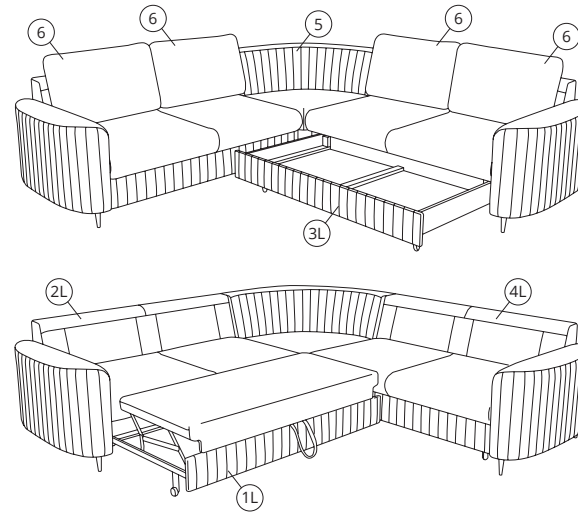



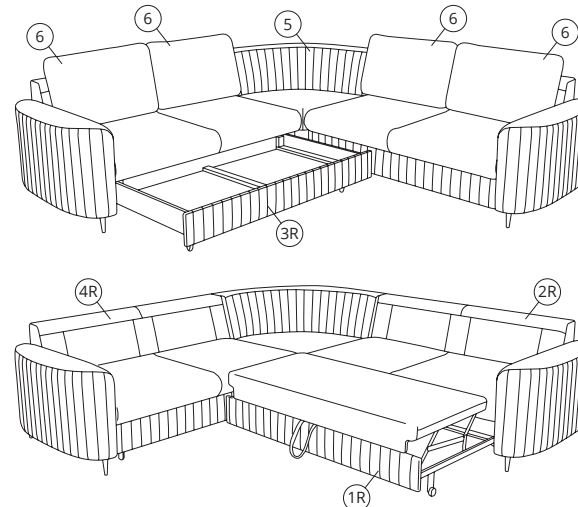

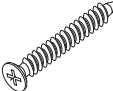
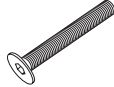
L

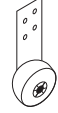

R

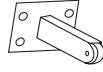

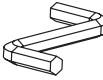
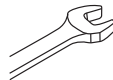
<p>E1 4 x 30 mm</p>  <p>x15</p>	<p>E2 5 x 40 mm</p>  <p>x4</p>
<p>F2</p>  <p>x4</p>	<p>F3</p>  <p>x4</p>
<p>F4</p>  <p>x2</p>	<p>GT1 h = 100 mm</p>  <p>x5</p>
<p>GT10 h = 45 mm</p>  <p>x4</p>	<p>GT17 h = 100 mm</p>  <p>x5</p>
<p>W1</p>  <p>x2</p>	<p>W2 4 x 15 mm</p>  <p>x8</p>
<p>XA</p>  <p>x1</p>	<p>XF</p>  <p>x1</p>

1

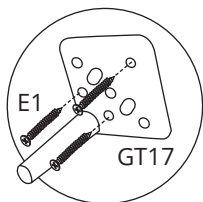
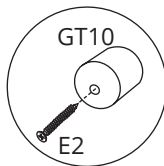
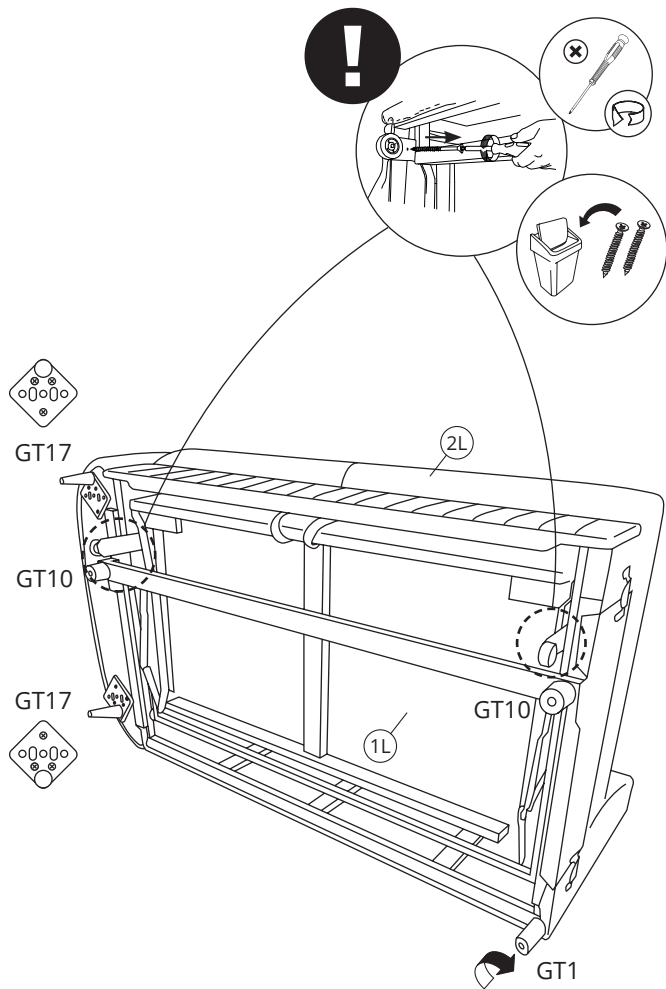

E1
4 x 30 mm



x6

E2
5 x 40 mm



x2

GT1
h = 100 mm



x1

GT10
h = 45 mm



x2

GT17
h = 100 mm



x2

2

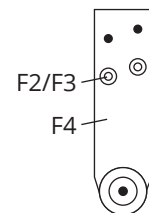
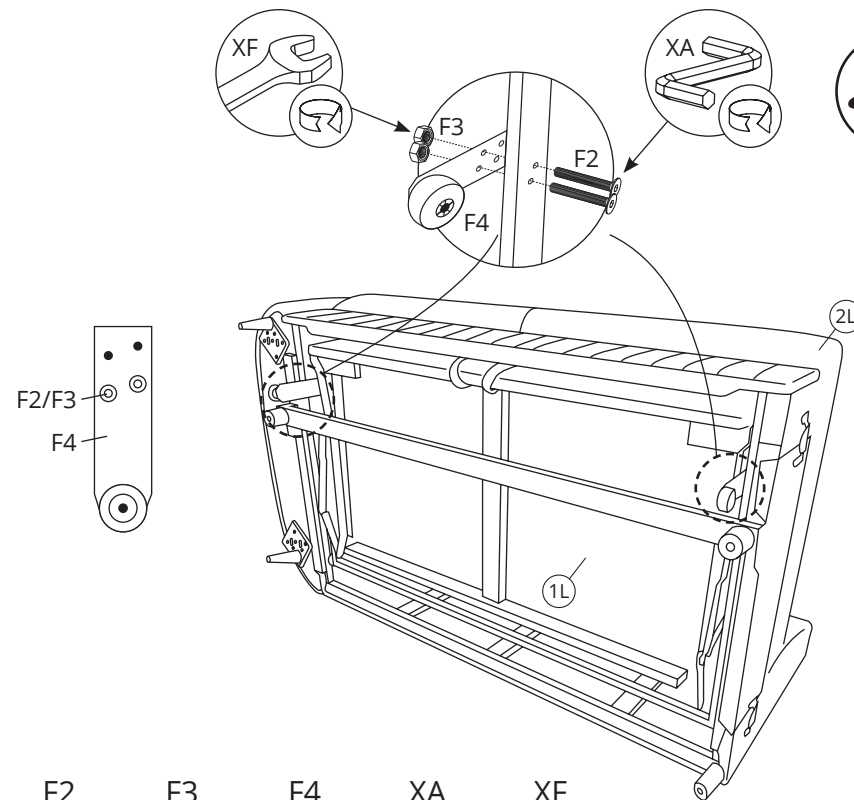

F2



x4

F3



x4

F4



x2

XA

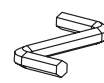

x1

XF



x1

3

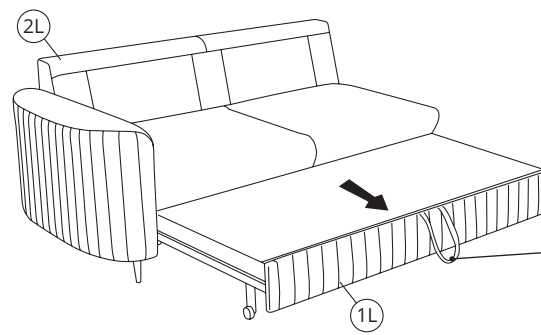

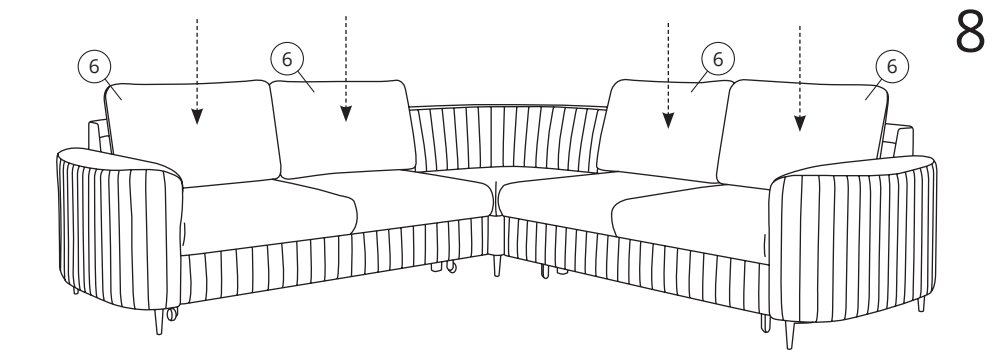
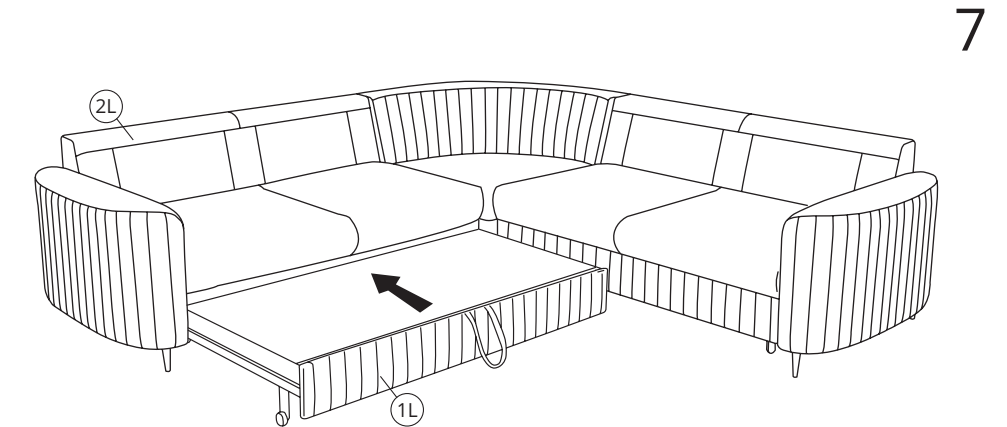
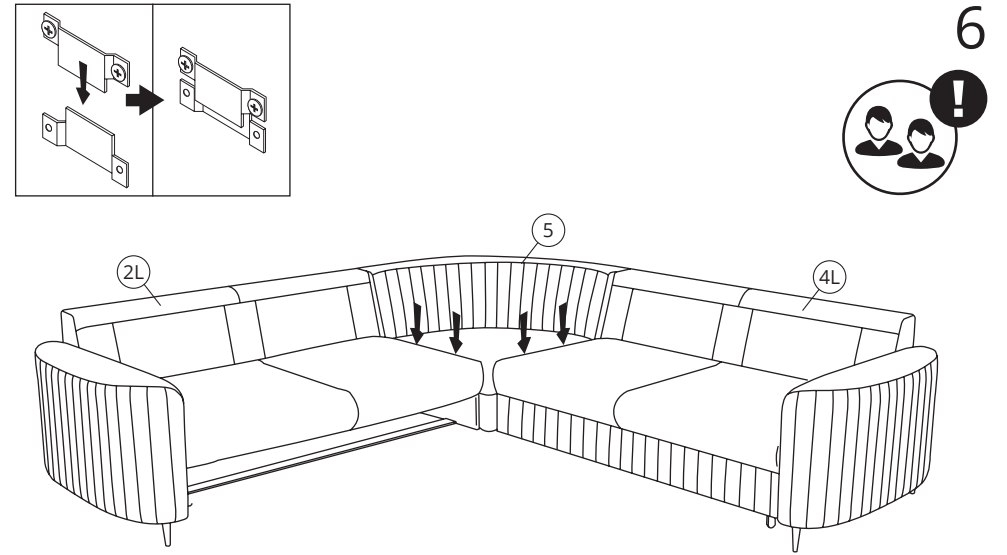
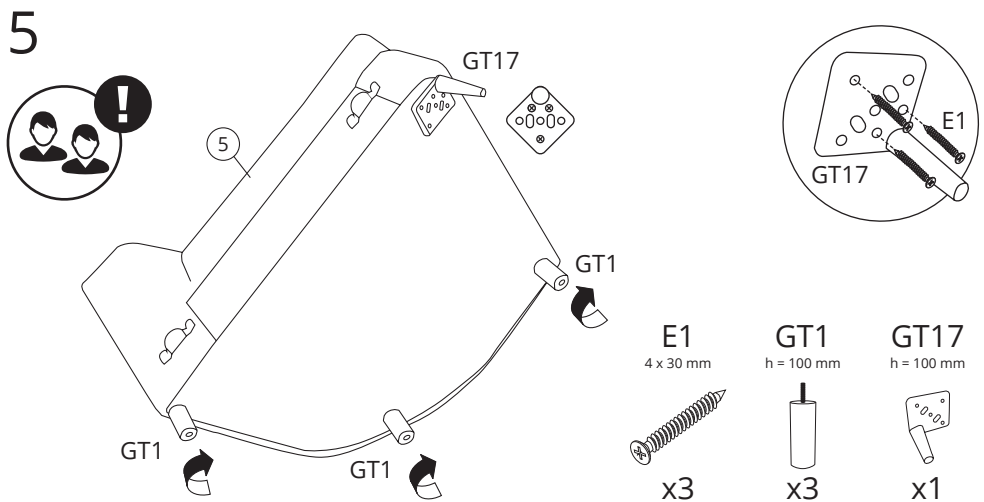
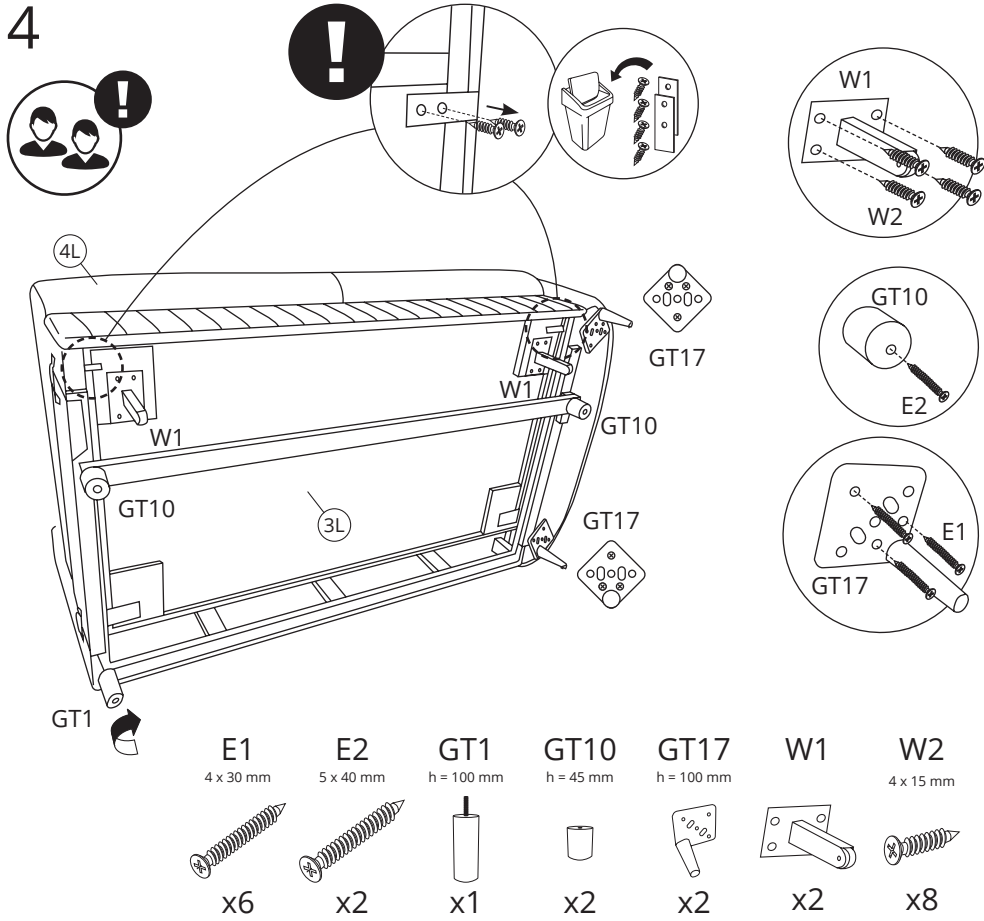

L

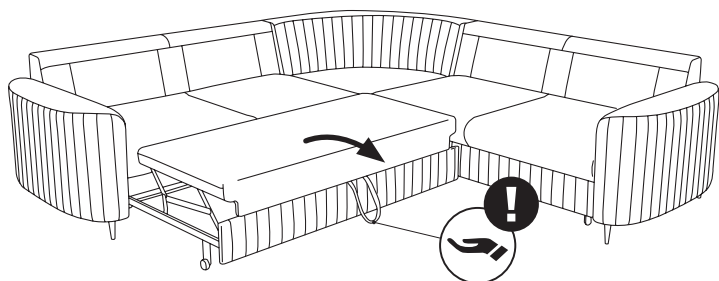
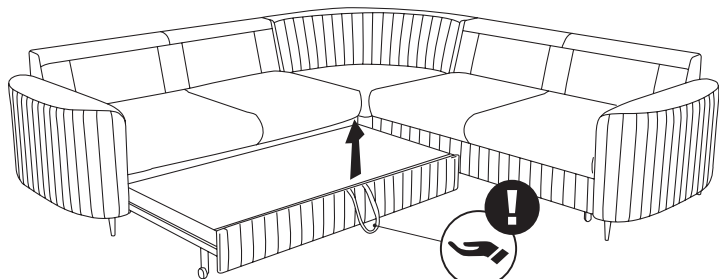
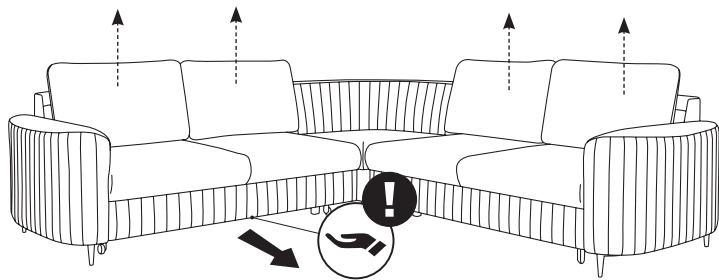
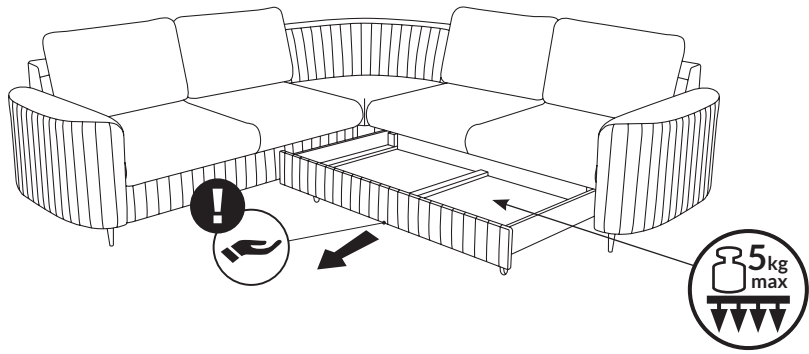

L

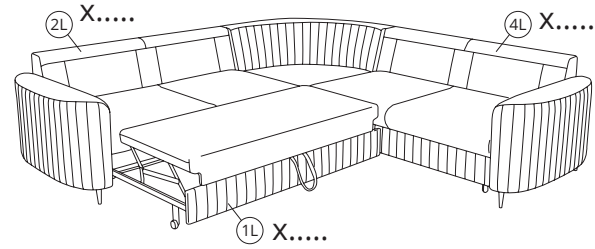
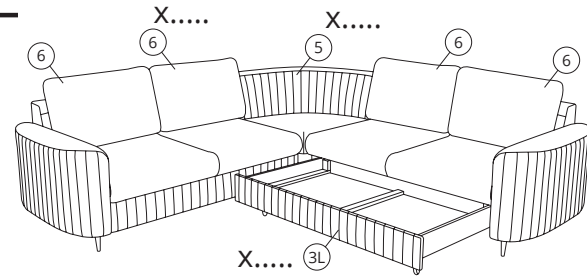

R

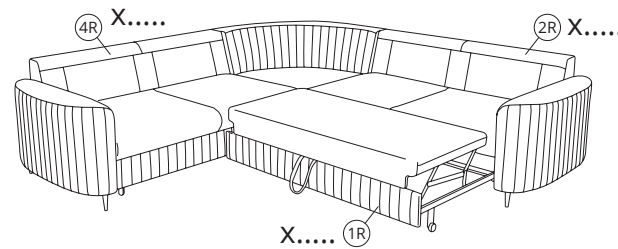
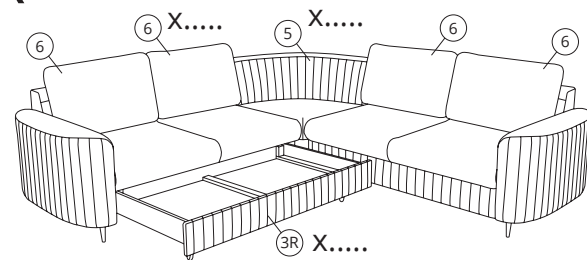

<p>E1 4 x 30 mm</p> <p>X.....</p>	<p>E2 5 x 40 mm</p> <p>X.....</p>
<p>F2</p> <p>X.....</p>	<p>F3</p> <p>X.....</p>
<p>F4</p> <p>X.....</p>	<p>GT1 h = 100 mm</p> <p>X.....</p>
<p>GT10 h = 45 mm</p> <p>X.....</p>	<p>GT17 h = 100 mm</p> <p>X.....</p>
<p>W1</p> <p>X.....</p>	<p>W2 4 x 15 mm</p> <p>X.....</p>
<p>XA</p> <p>X.....</p>	<p>XF</p> <p>X.....</p>

