







MM

<b>A1</b> 8 x 35 mm x12 	<b>C2</b> 5 x 13 mm x4 	<b>C4</b> 6.3 x 13 mm x2 
<b>E0</b> x8 	<b>E1</b> 15 x 12 mm x8 	<b>F1</b> 6 x 34 mm x8 
<b>M</b> x1 	<b>P1</b> x2 	<b>R8</b> x2 
<b>S14</b> x2 		



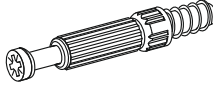
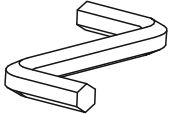

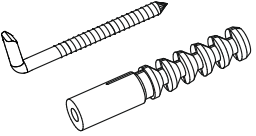
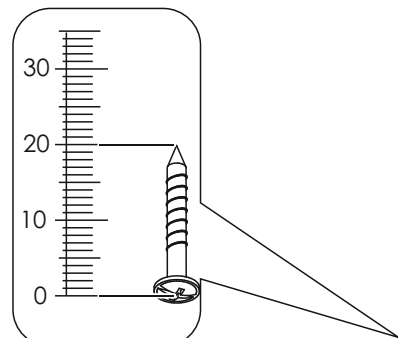
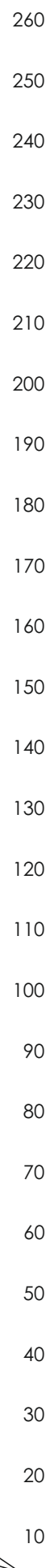
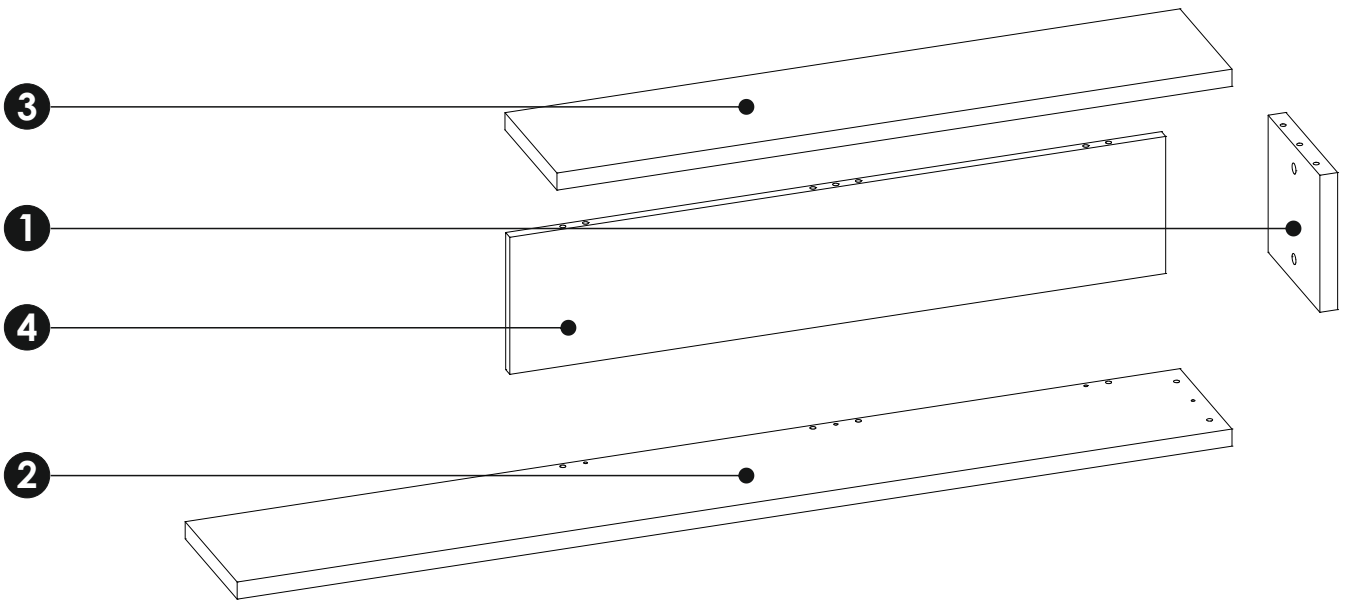
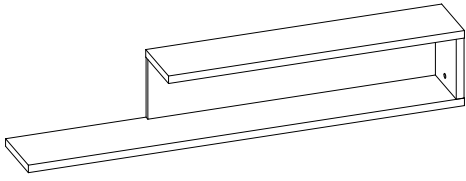
<b>1</b>	200	200	25	x1	1/1
<b>2</b>	1400	201	25	x1	1/1
<b>3</b>	950	201	25	x1	1/1
<b>4</b>	923	200	16	x1	1/1

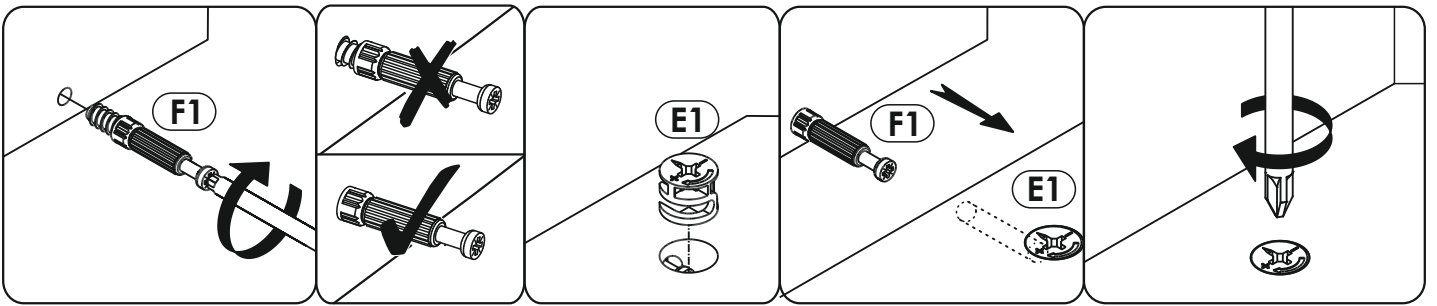

1 ▶

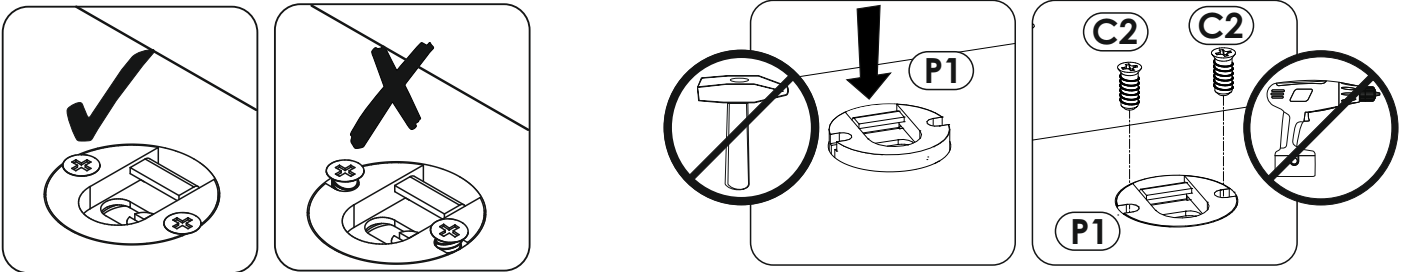
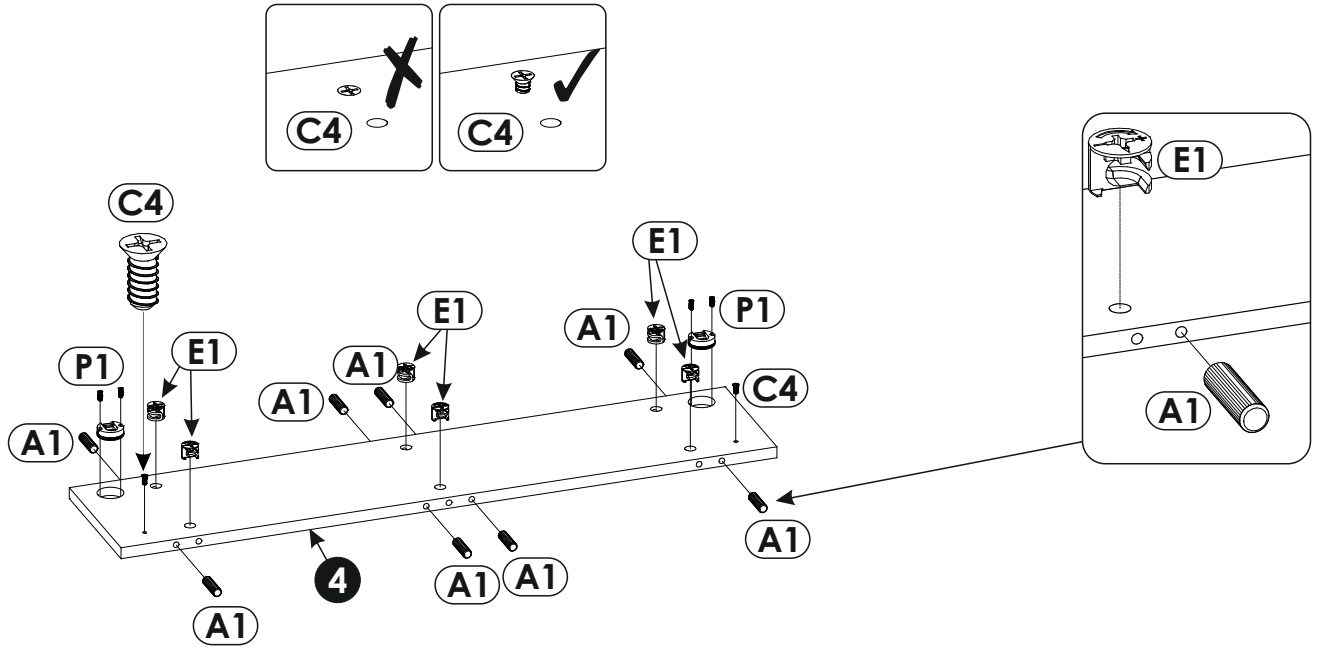

2 ▶

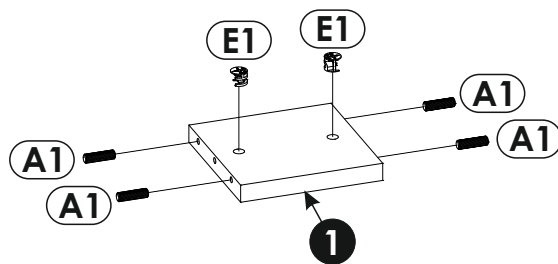

3 ▶

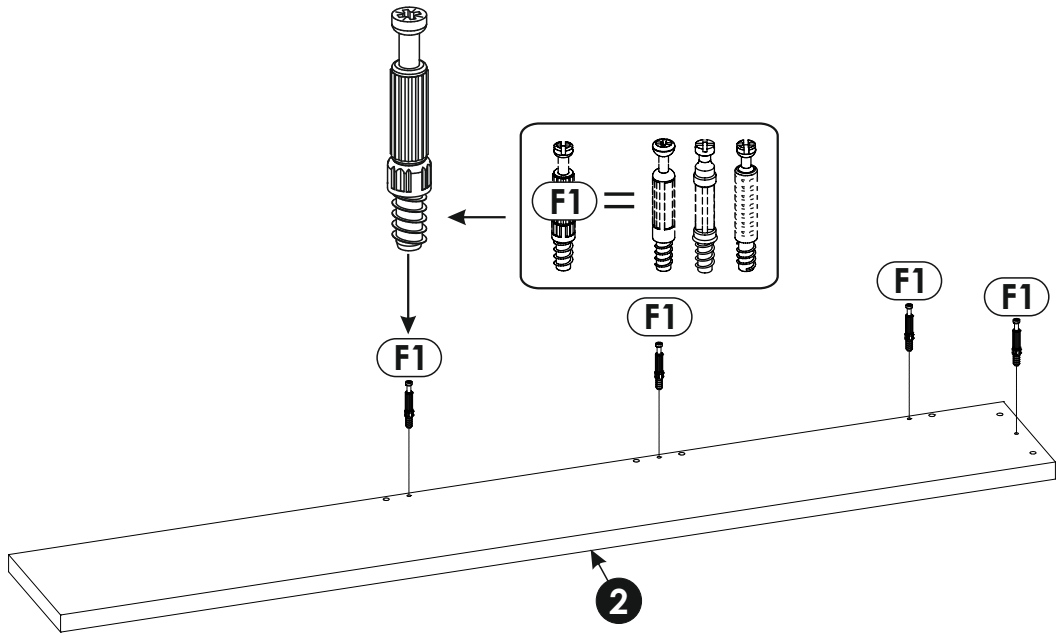

4 ▶

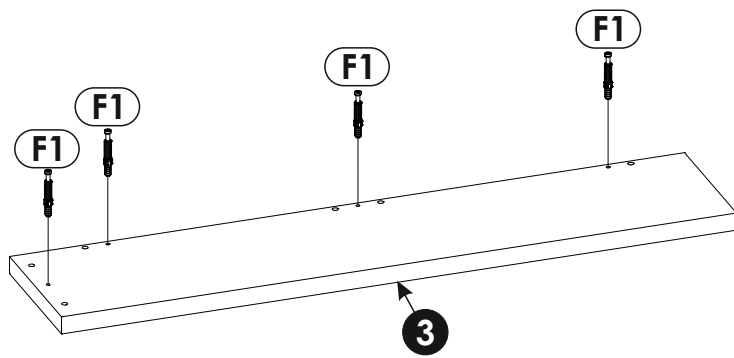

5 ▶

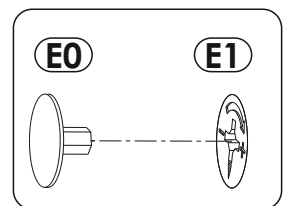
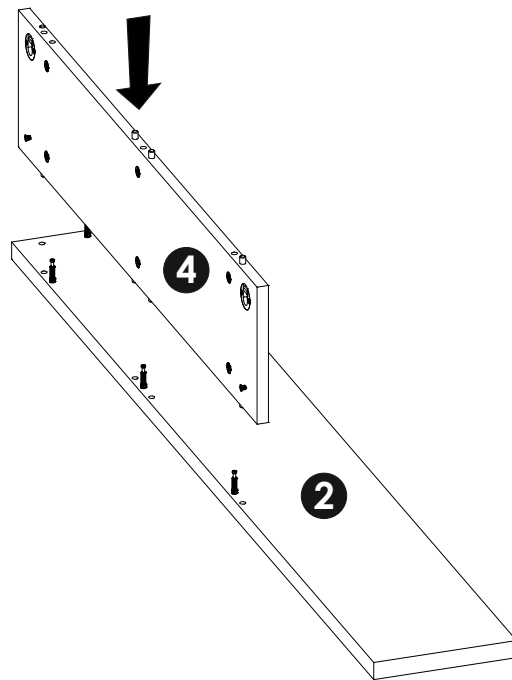
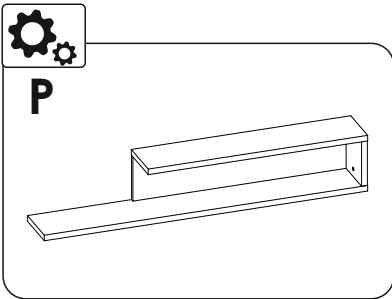
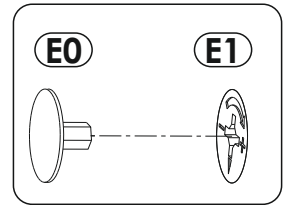
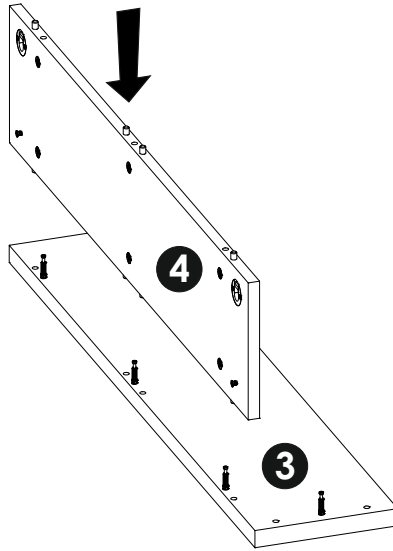
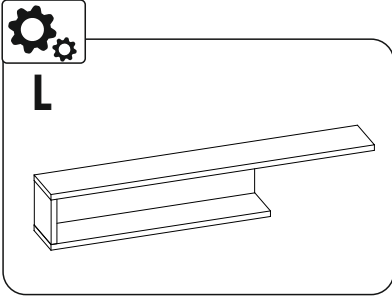

6 ▶

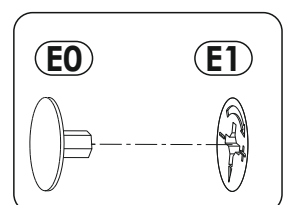
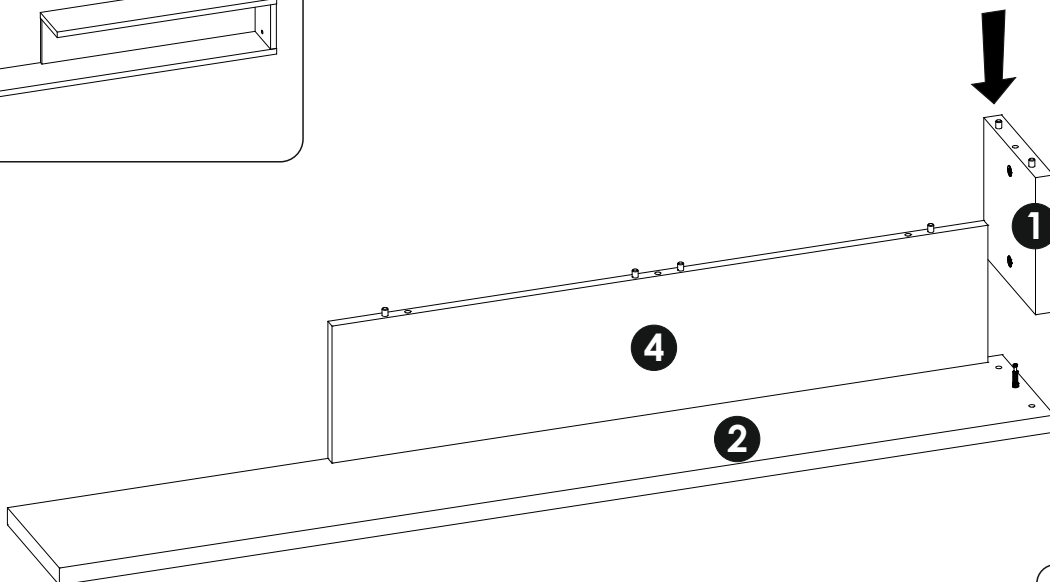
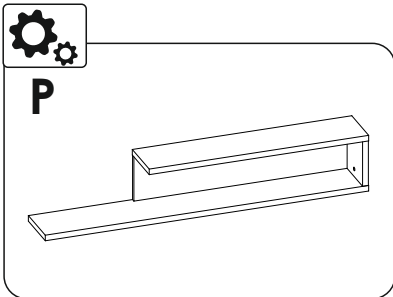
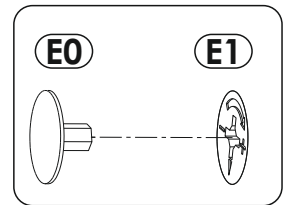
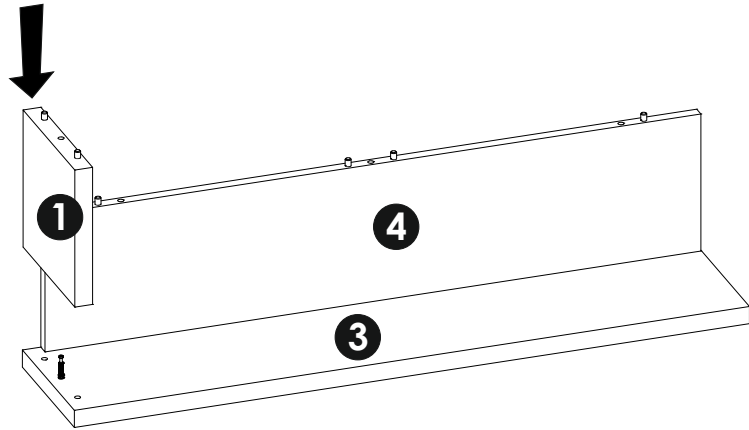
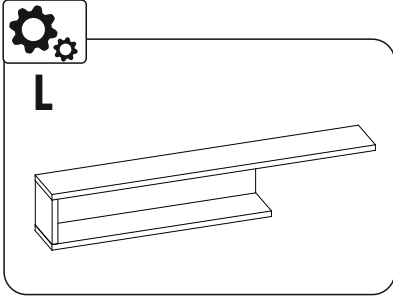



7 ▶

