



	M4 25mmx4  x6	 x3	 x2	W4 16mmx3,5  x4
---	--	---	---	--





W x2	M x30	B2 8x35mm x20	C x12	D x12
E1 x4	E2 x4	W1 3,5x16 x22	 x1	H x2

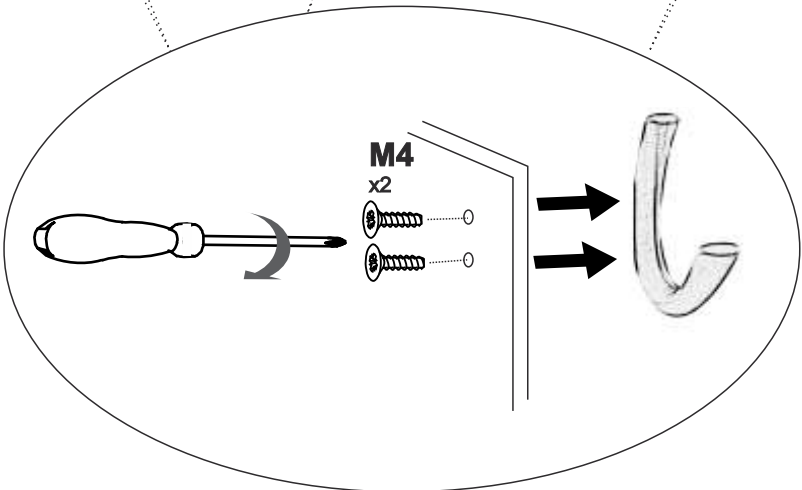
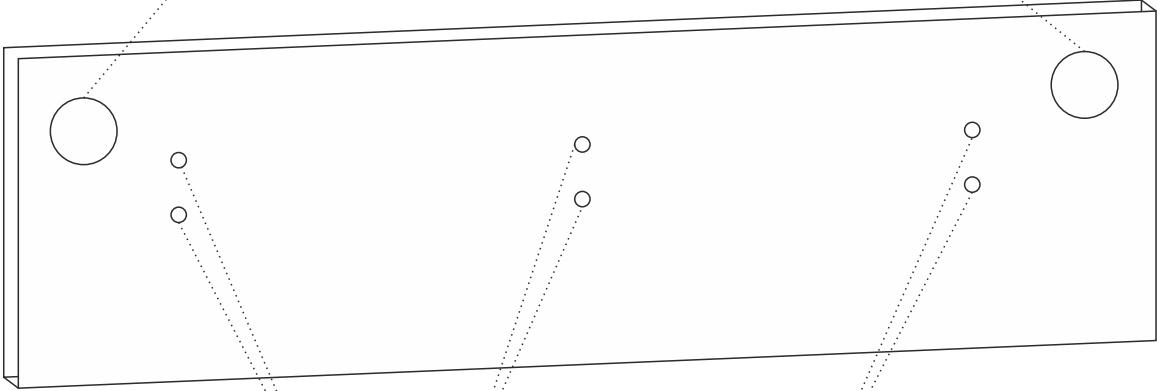
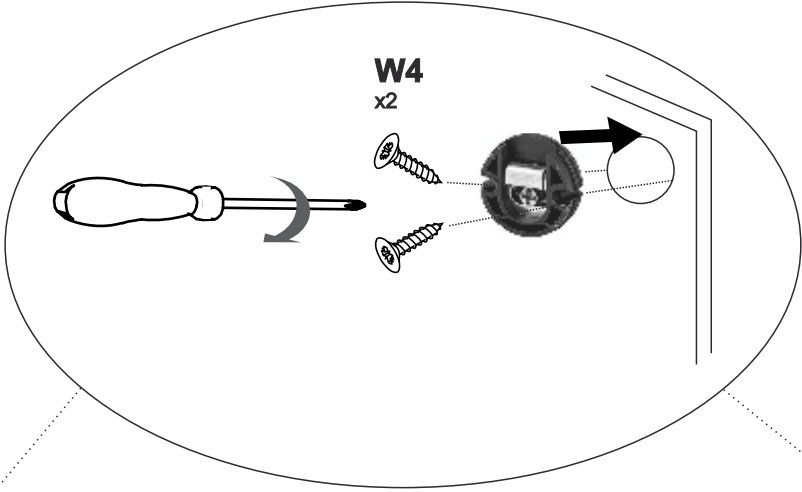
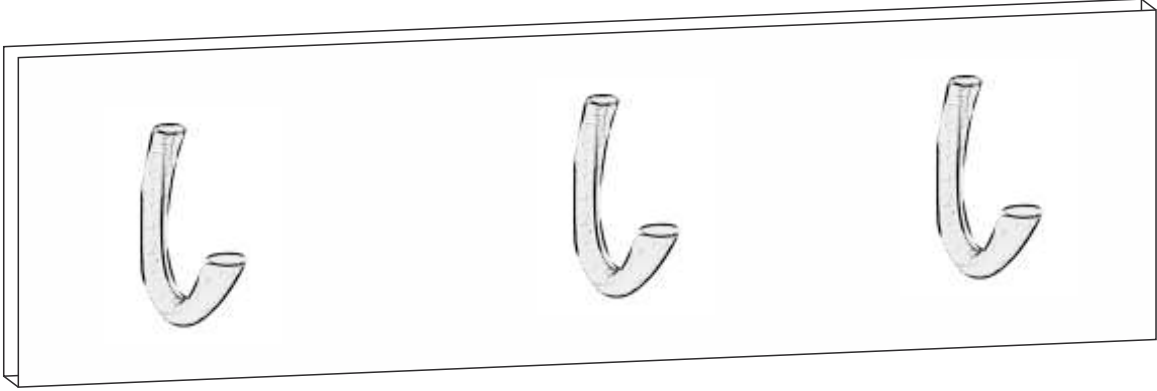
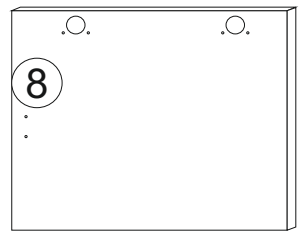
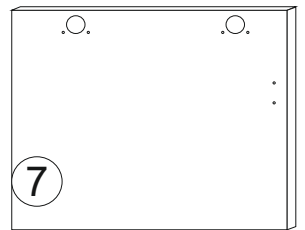
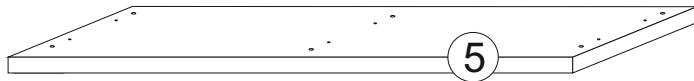
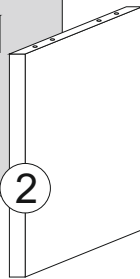
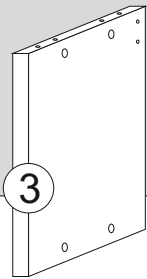
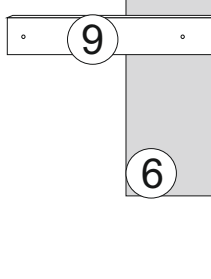
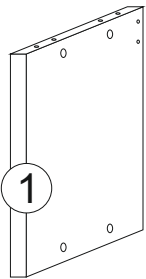
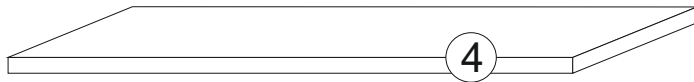
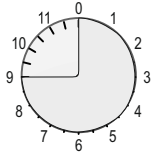
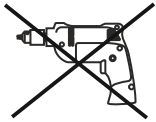
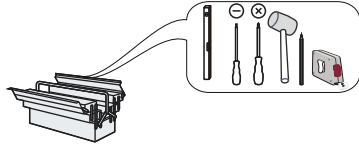
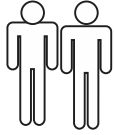
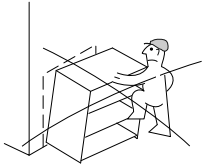
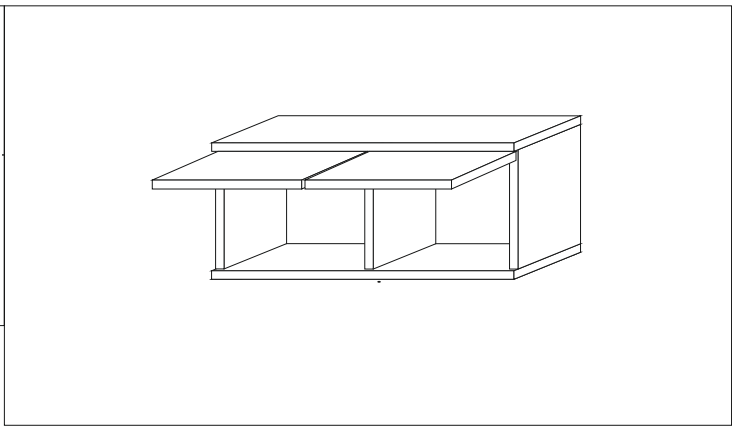
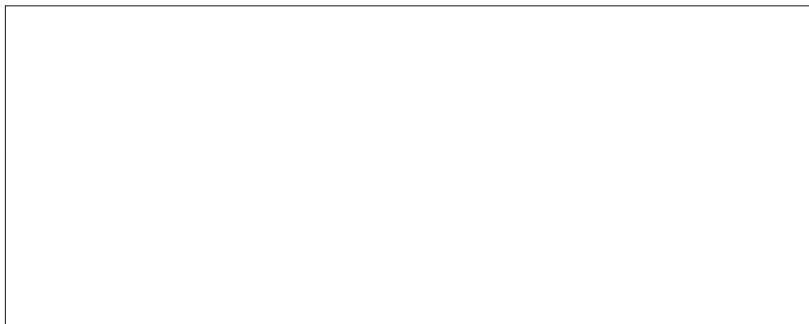
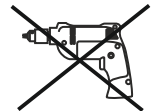
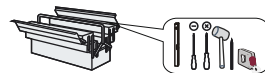
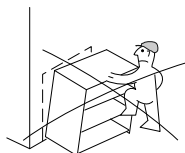

I

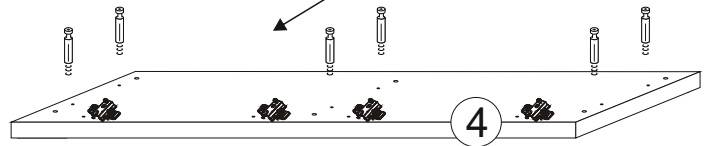
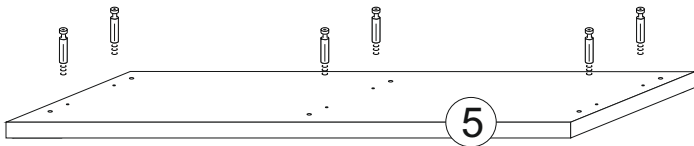
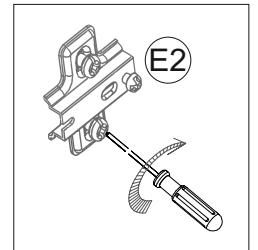
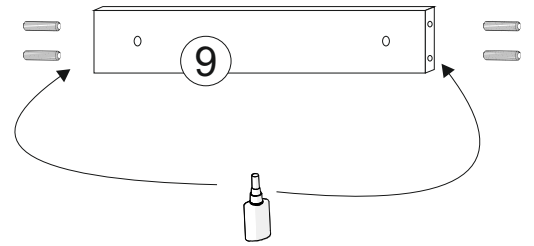
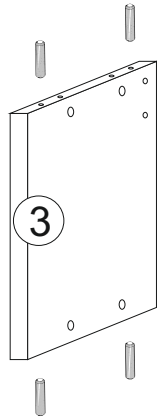
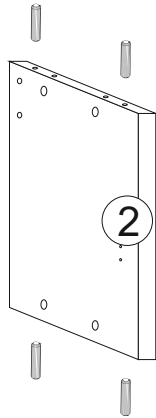
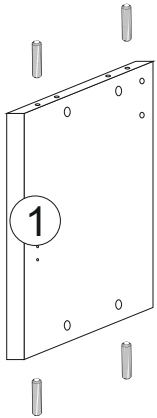
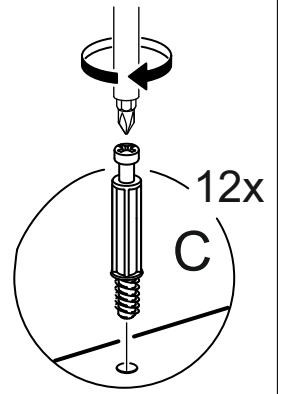
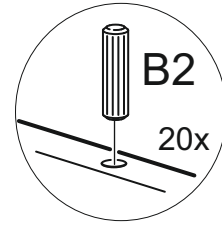
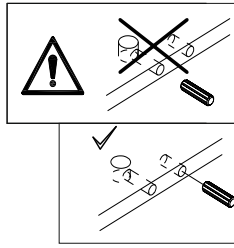
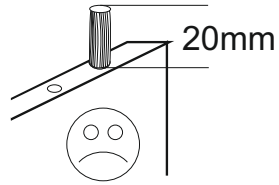
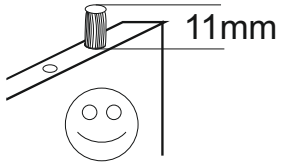

II

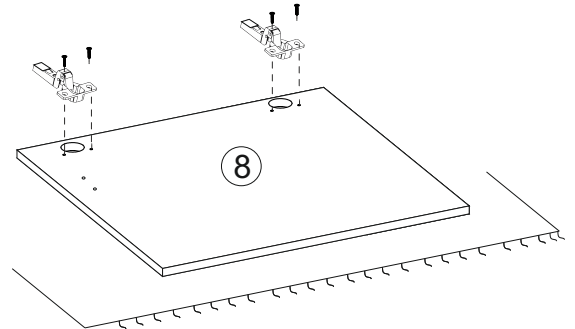
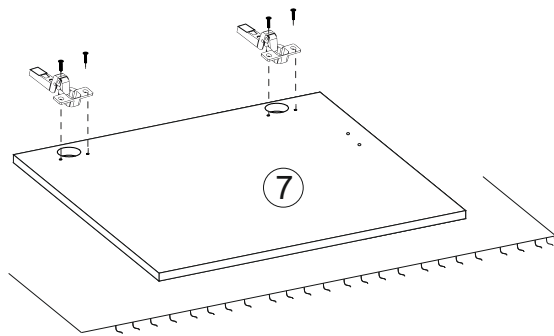
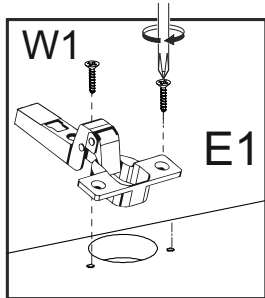

III

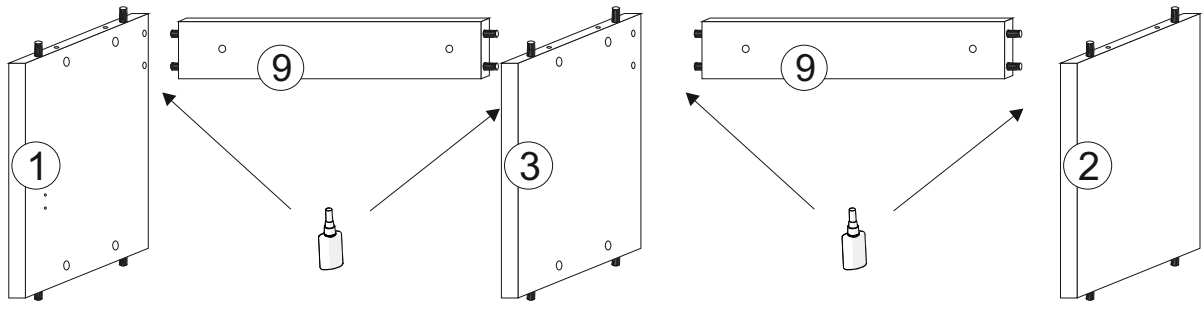

IV

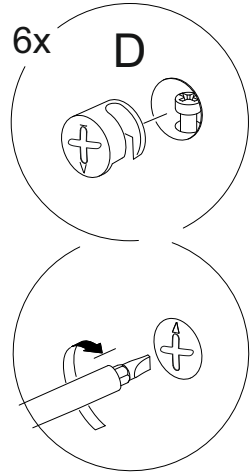
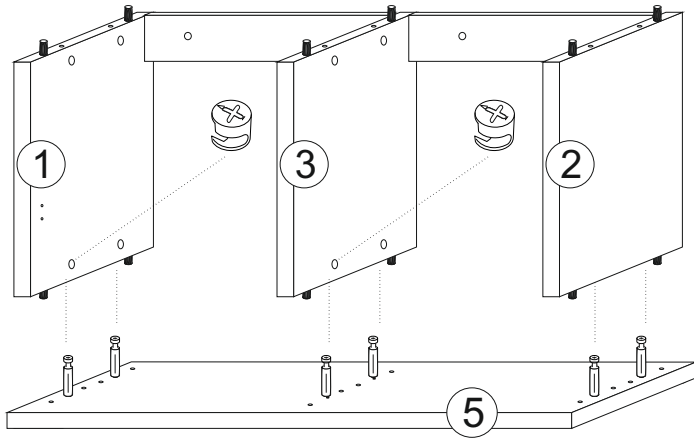

6x

D

V

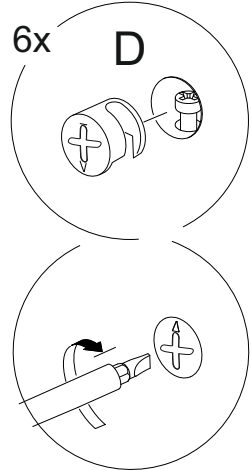
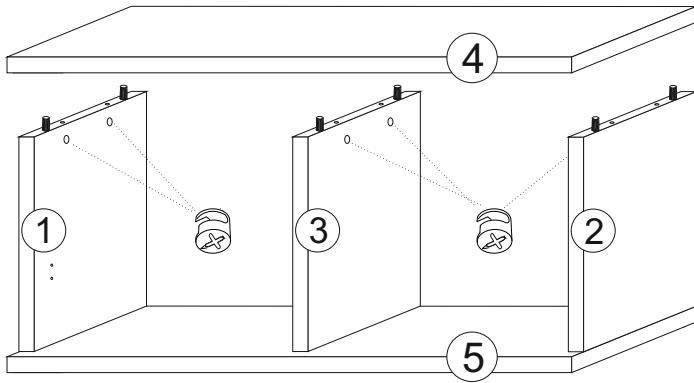

6x

D

VI

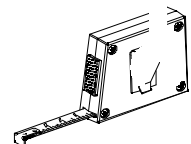
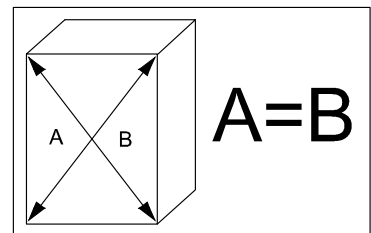
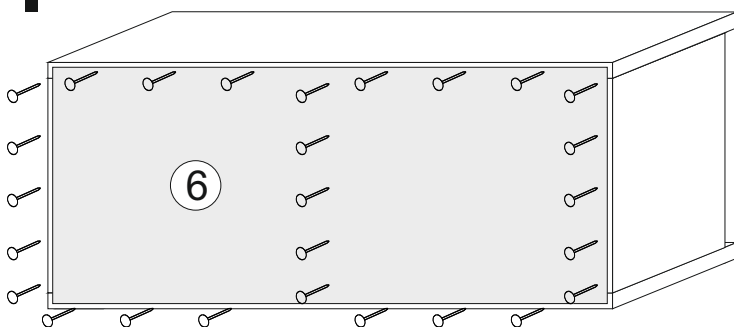

VII

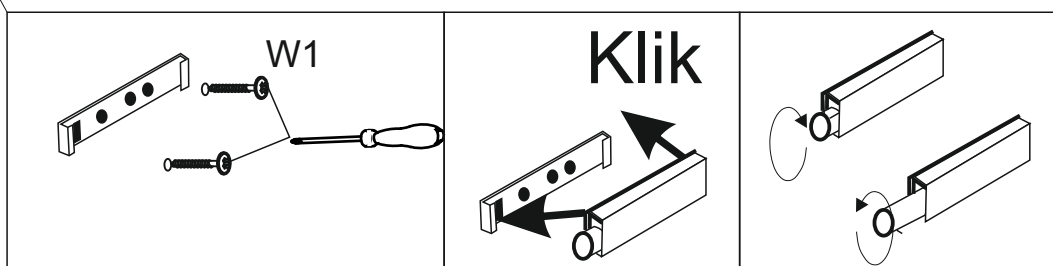
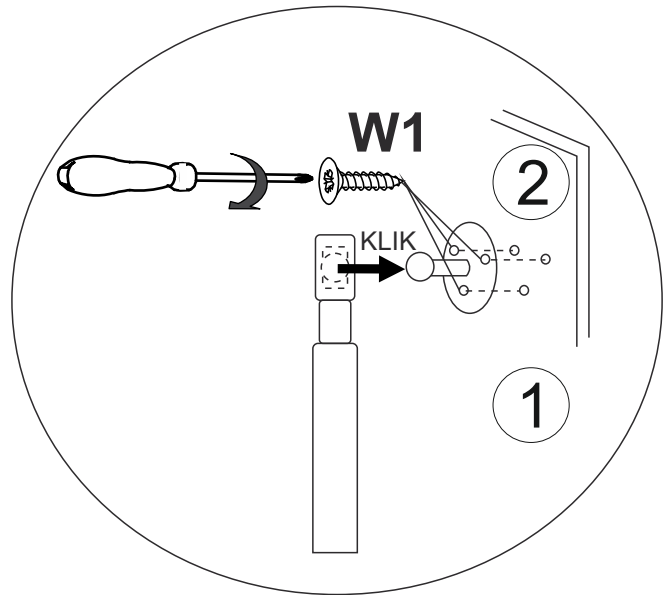
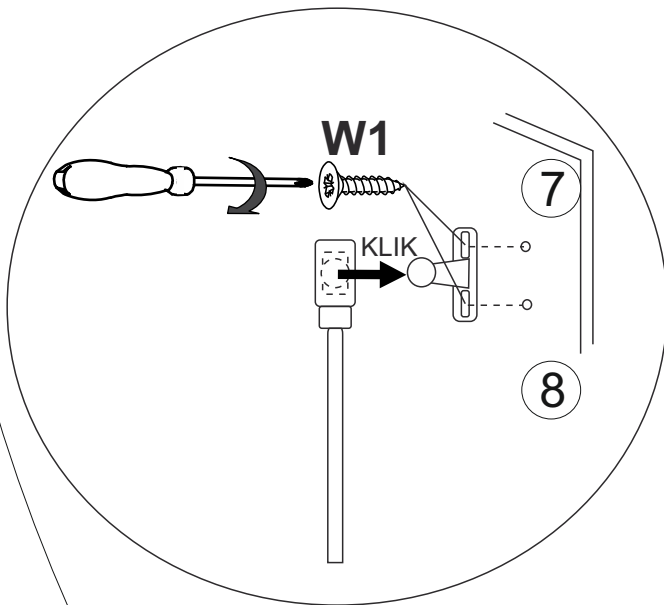
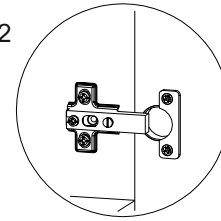
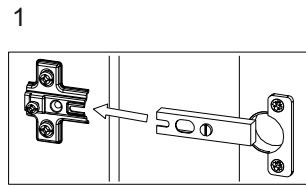
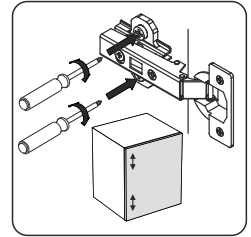
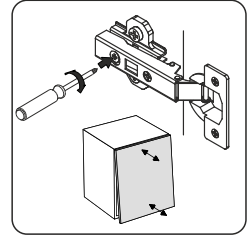
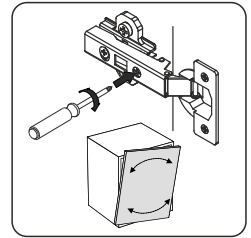
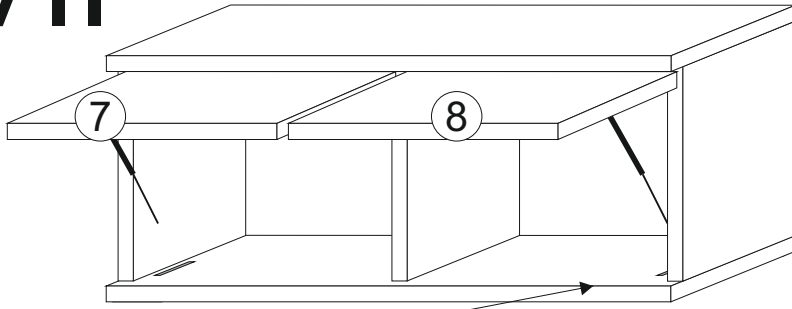

VIII

