

1

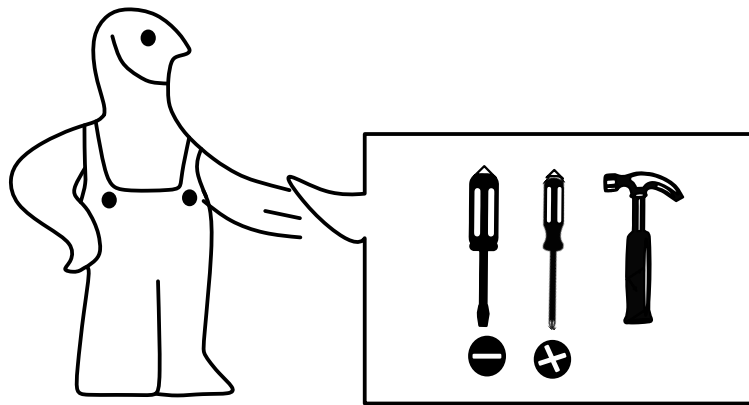

2

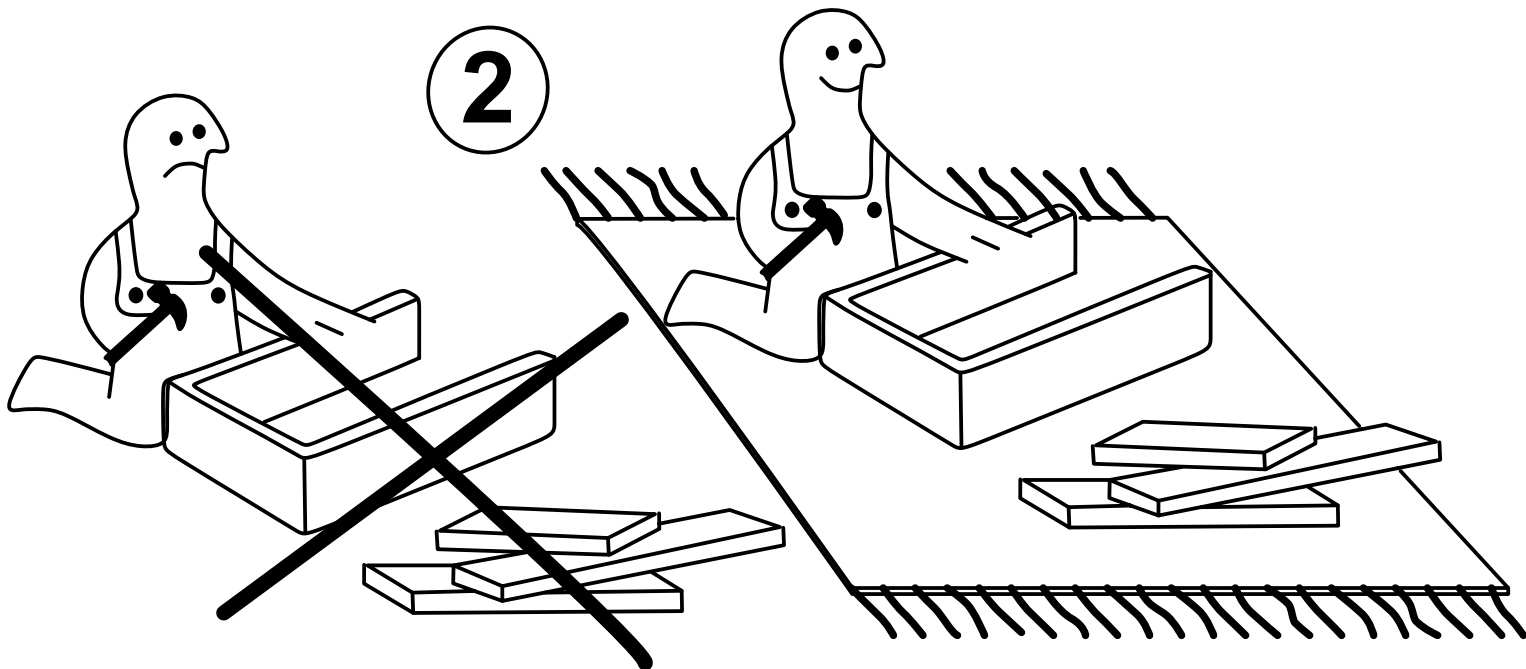

3



4

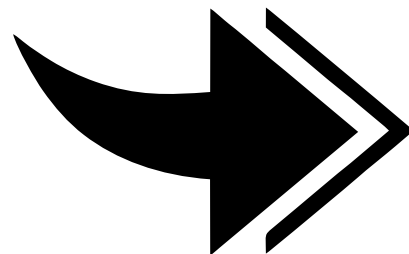
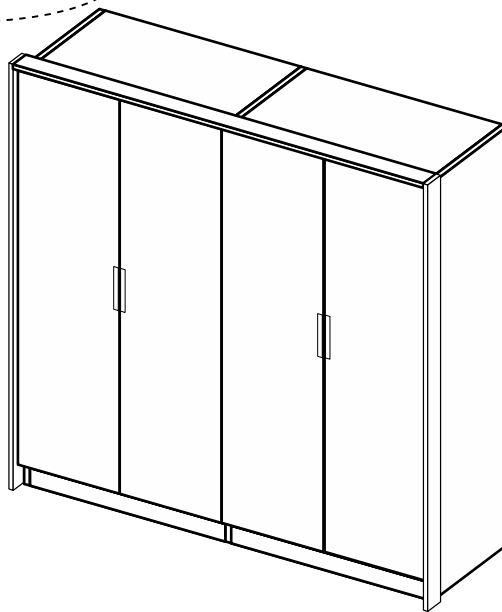
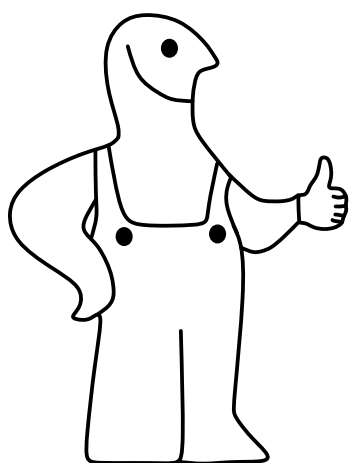

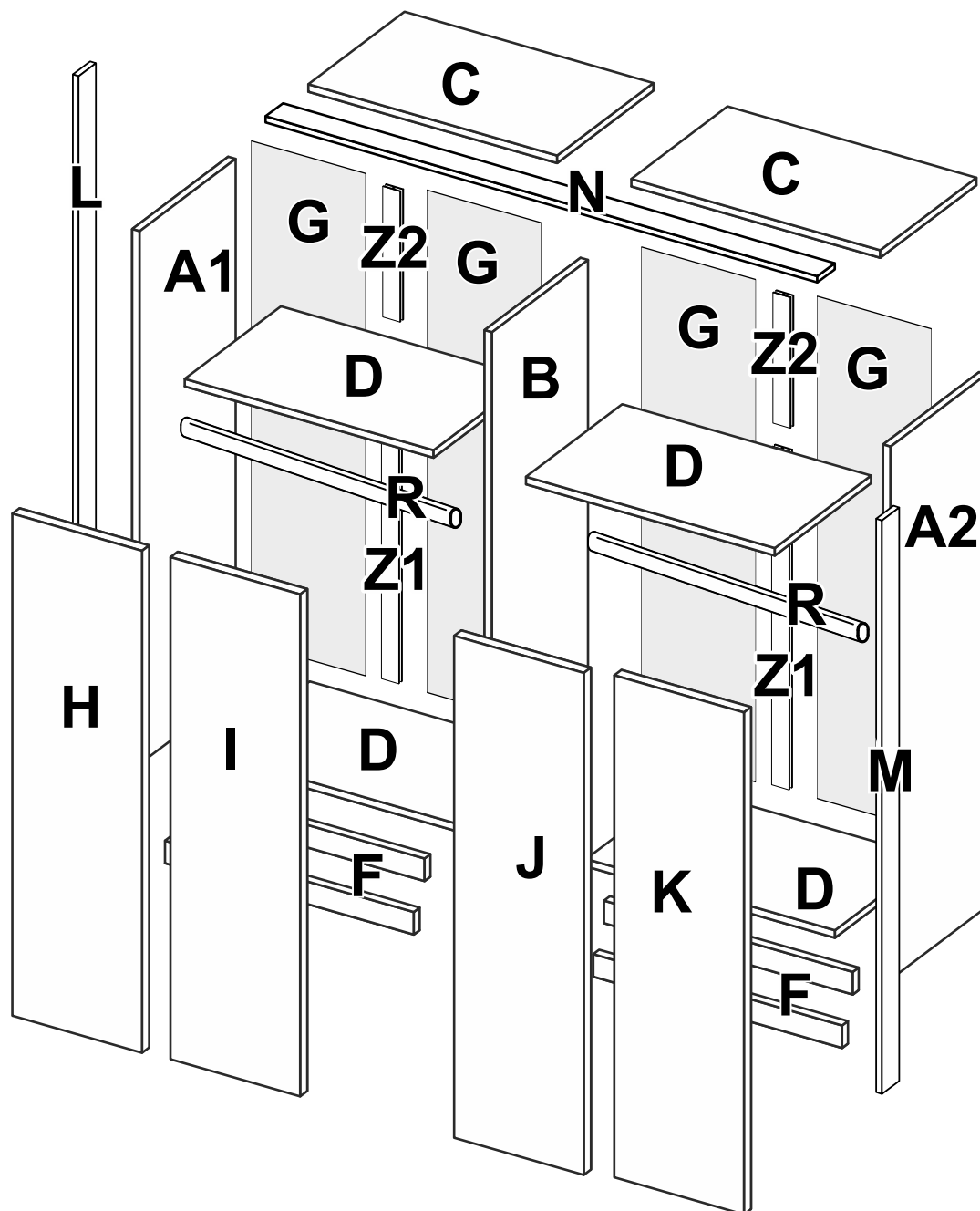

A1 - 2104 x 530 x 16 - x 1
A2 - 2104 x 530 x 16 - x 1
B - 2104 x 516 x 16 - x 1
C - 872 x 516 x 16 - x 2
D - 872 x 516 x 16 - x 4
F - 872 x 50 x 16 - x 4
G - 2054 x 442 x 3 - x 4
H - 2050 x 444 x 16 - x 1
I - 2050 x 444 x 16 - x 1

J - 2050 x 444 x 16 - x 1
K - 2050 x 444 x 16 - x 1
L - 2118 x 150 x 16 - x 1
M - 2118 x 150 x 16 - x 1
N - 1790 x 150 x 16 - x 1
R - 866MM
Z1 - 1606MM x 1
Z2 - 394MM x 1

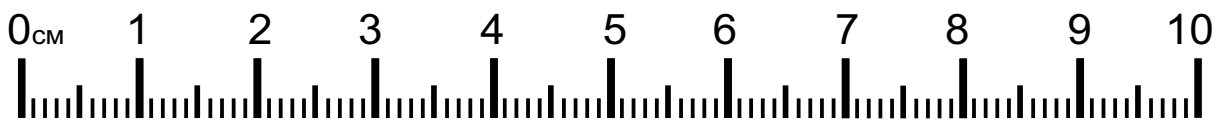
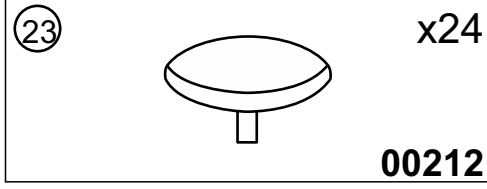
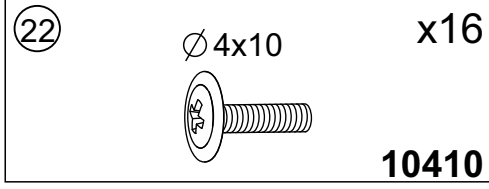
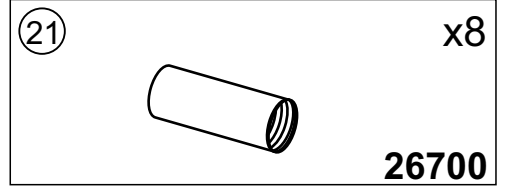
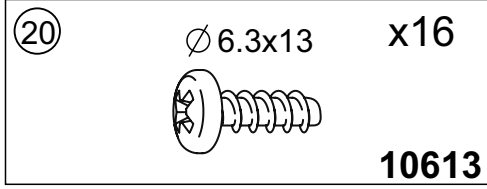
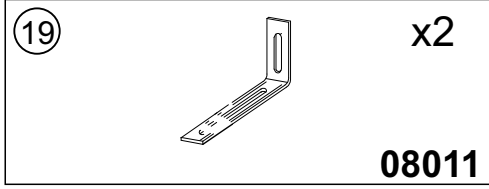
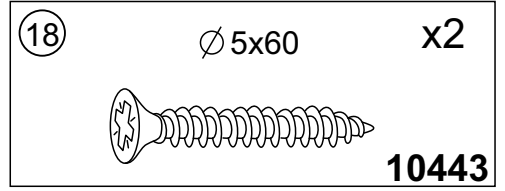
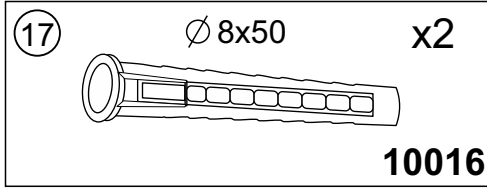
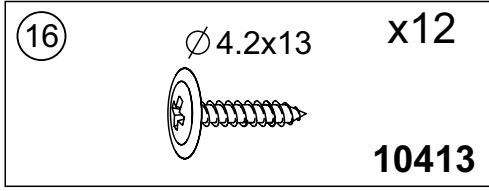
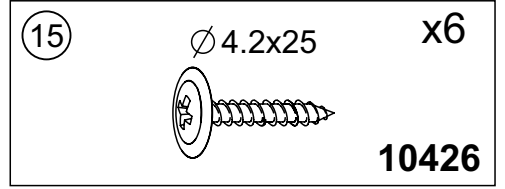
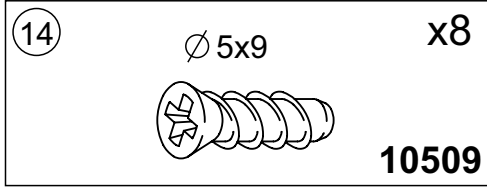
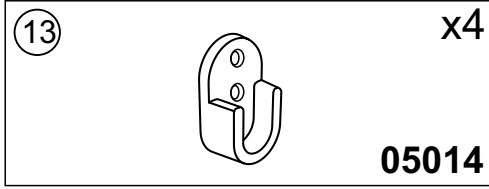
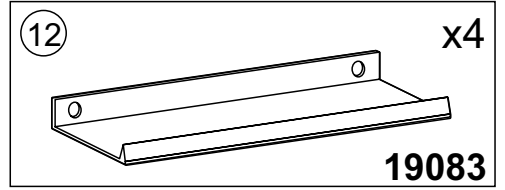
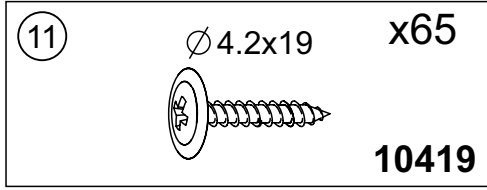
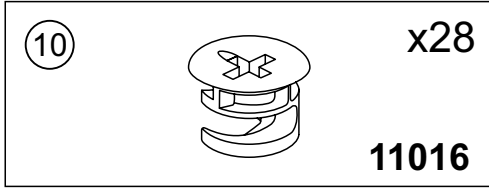
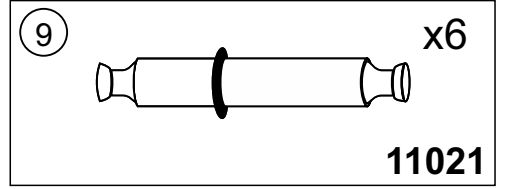
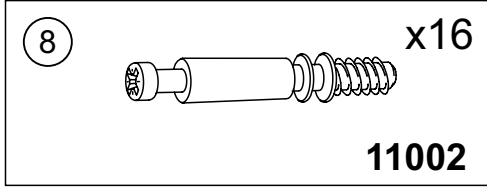
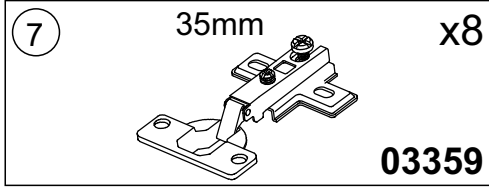
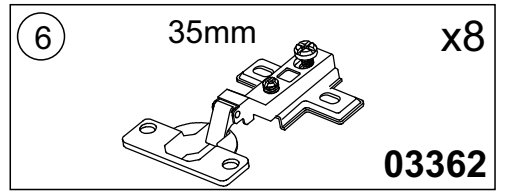
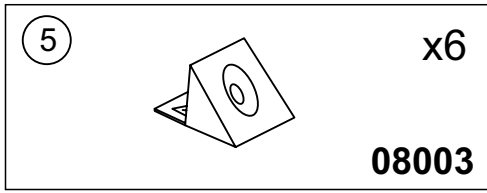
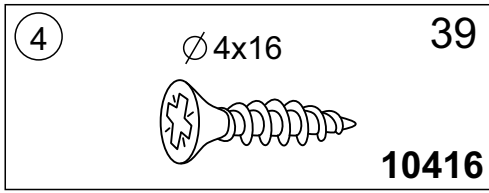
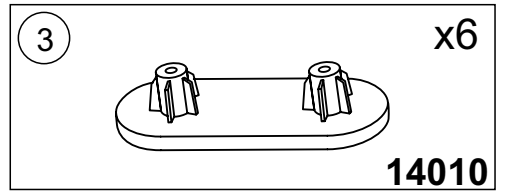
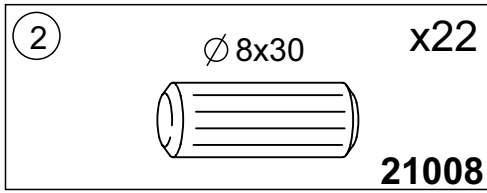
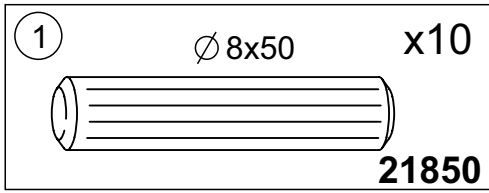

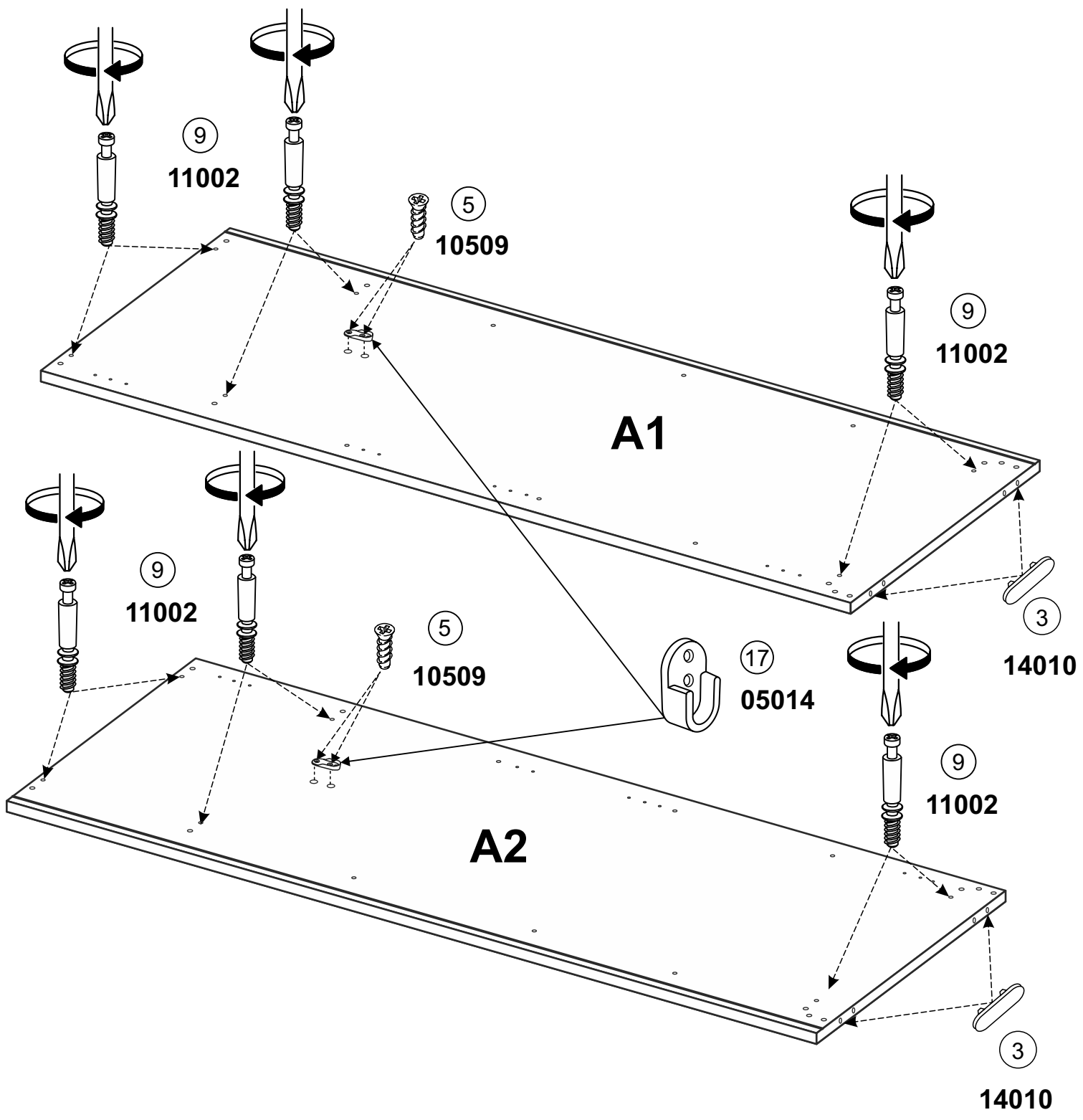

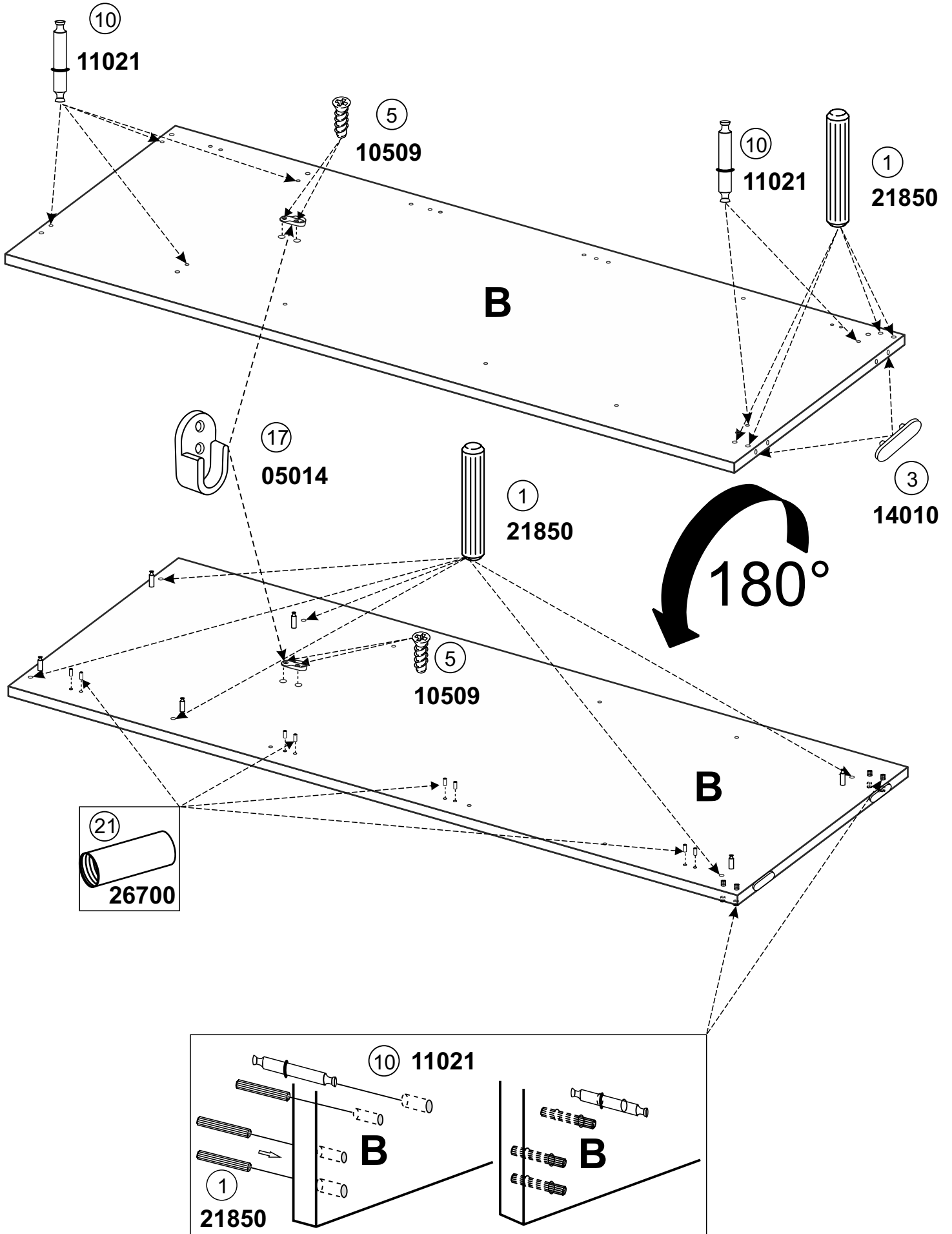

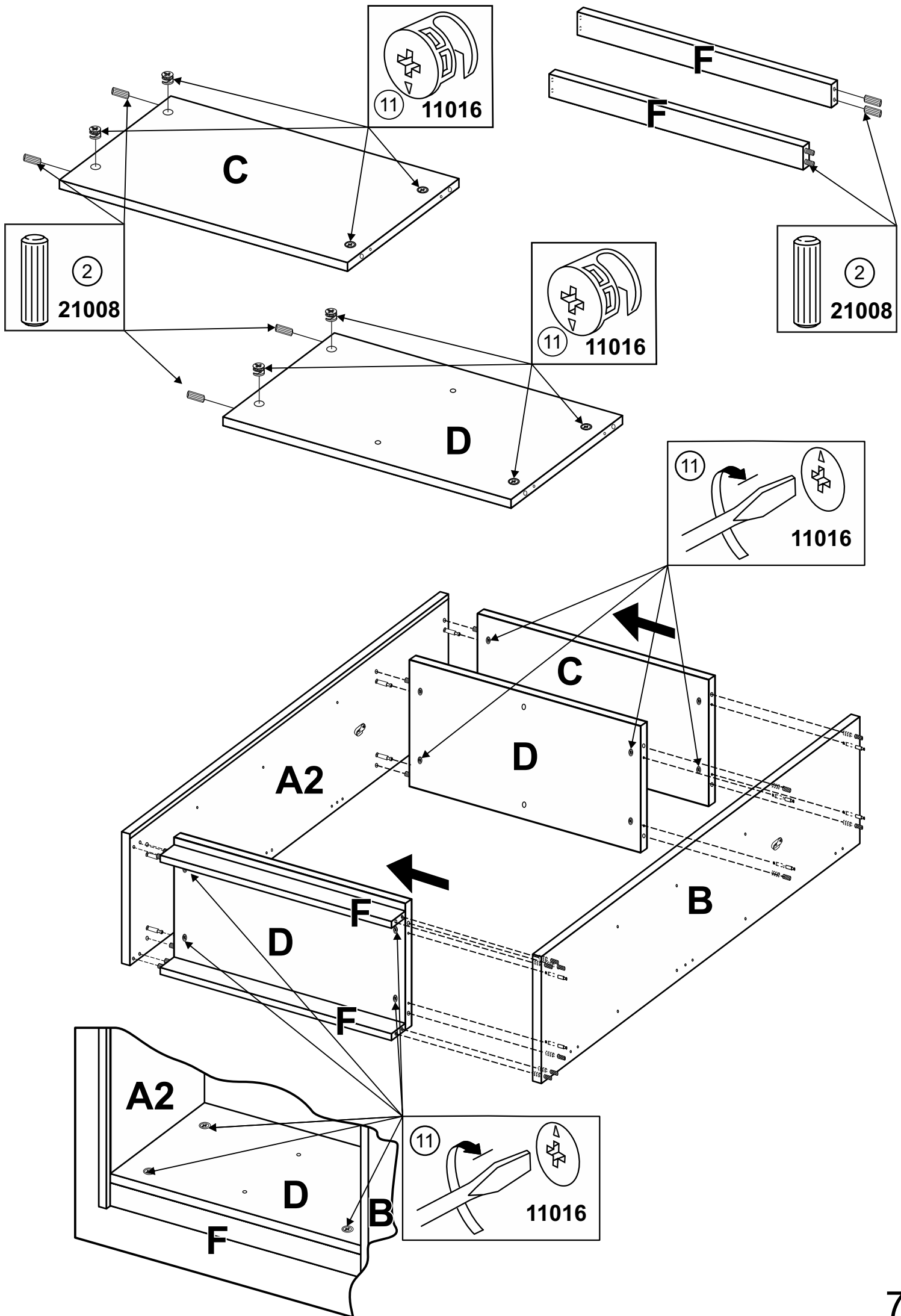

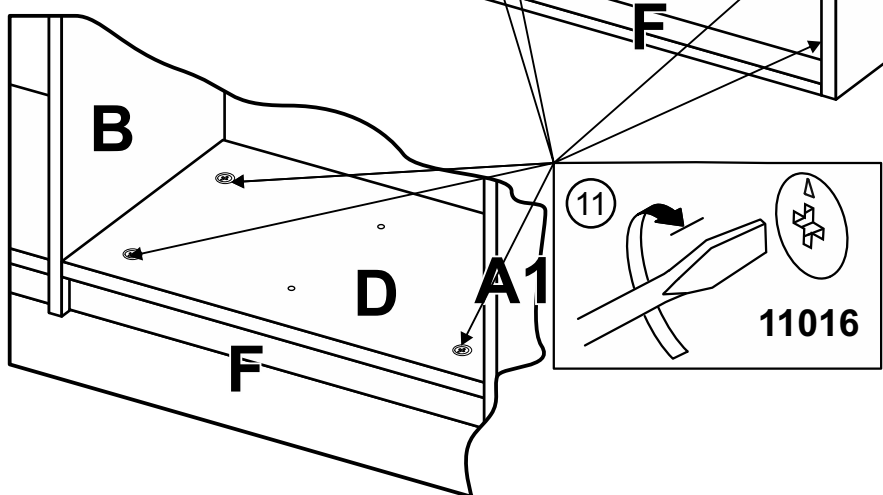
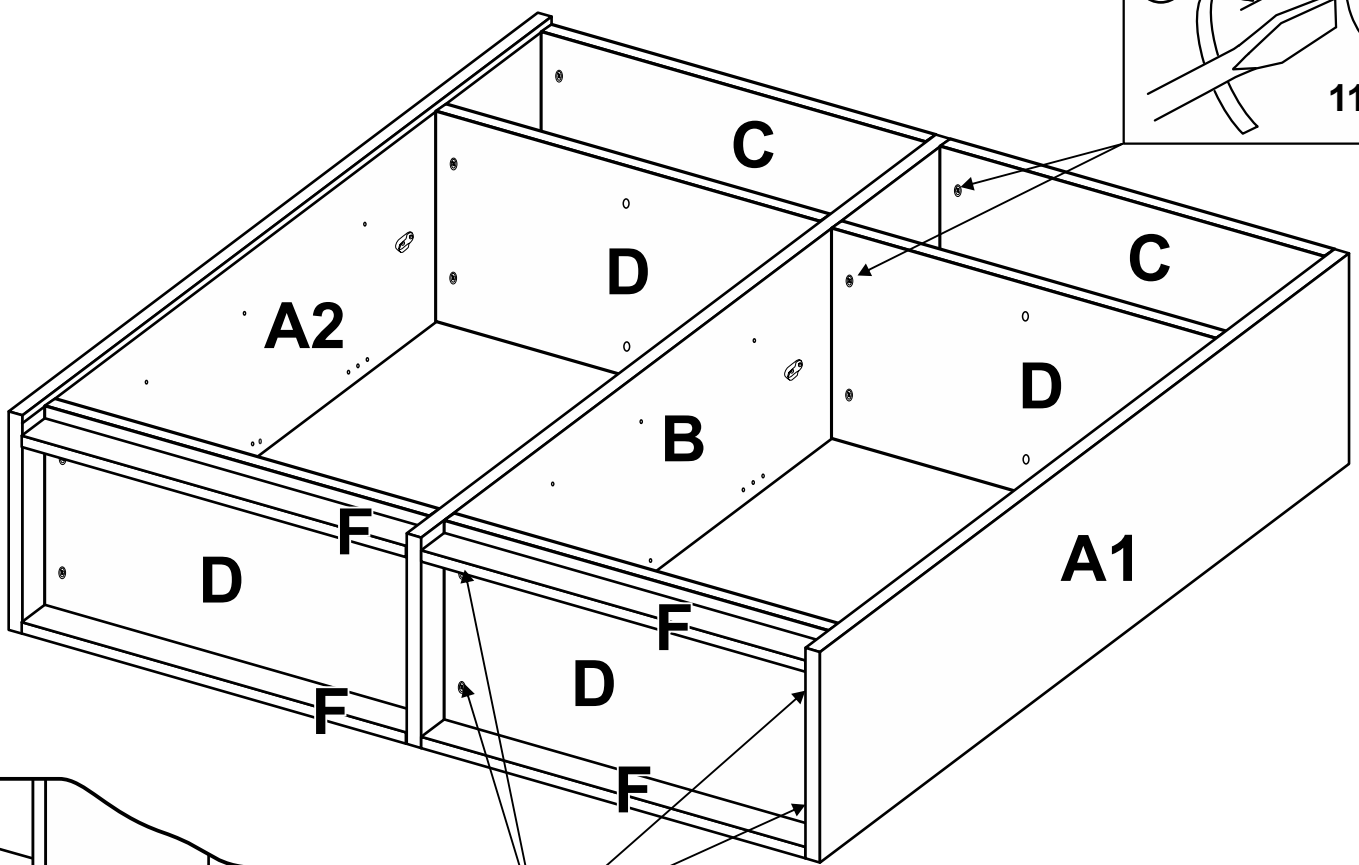
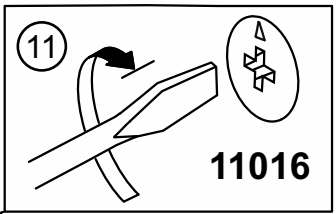
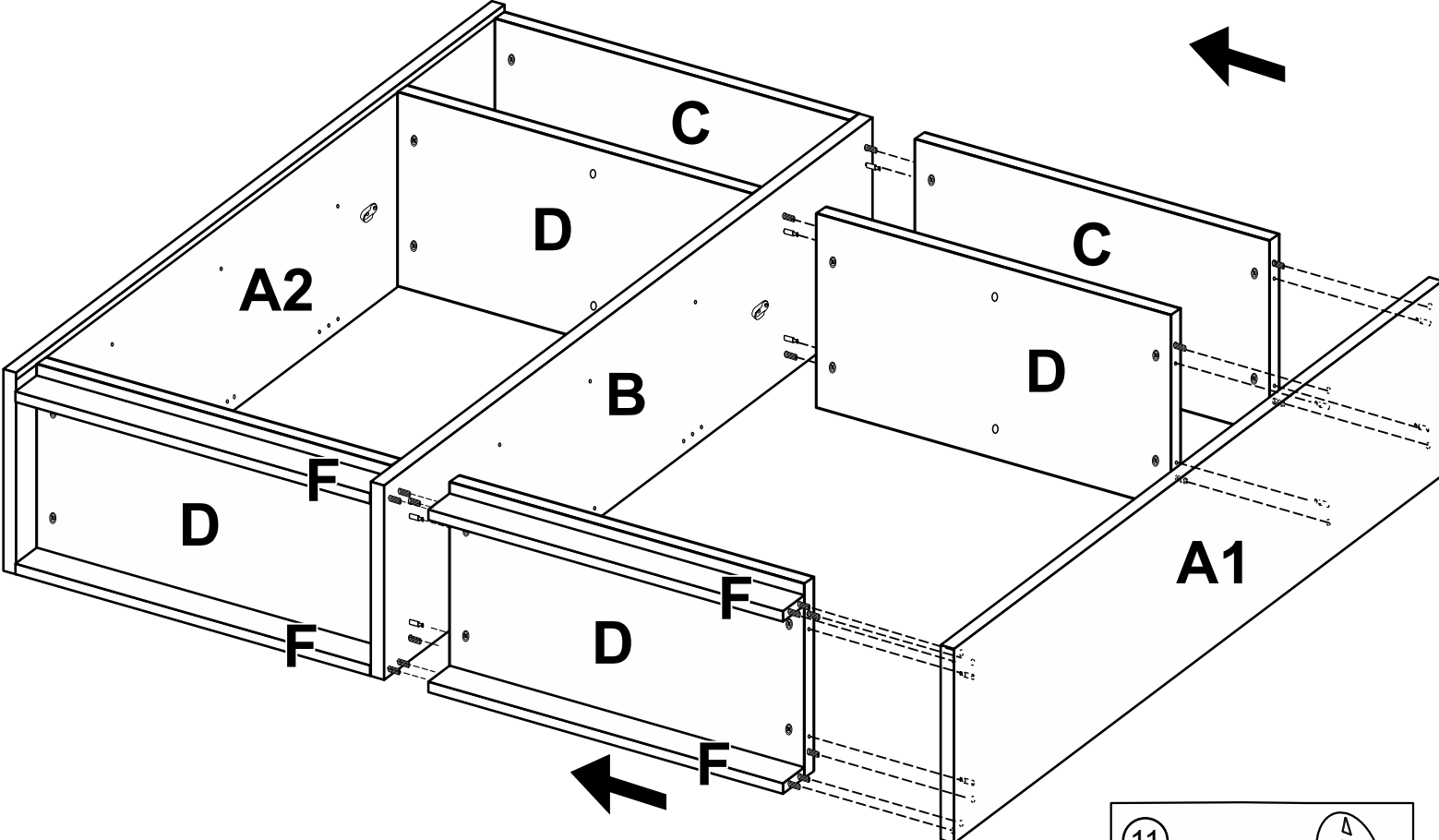

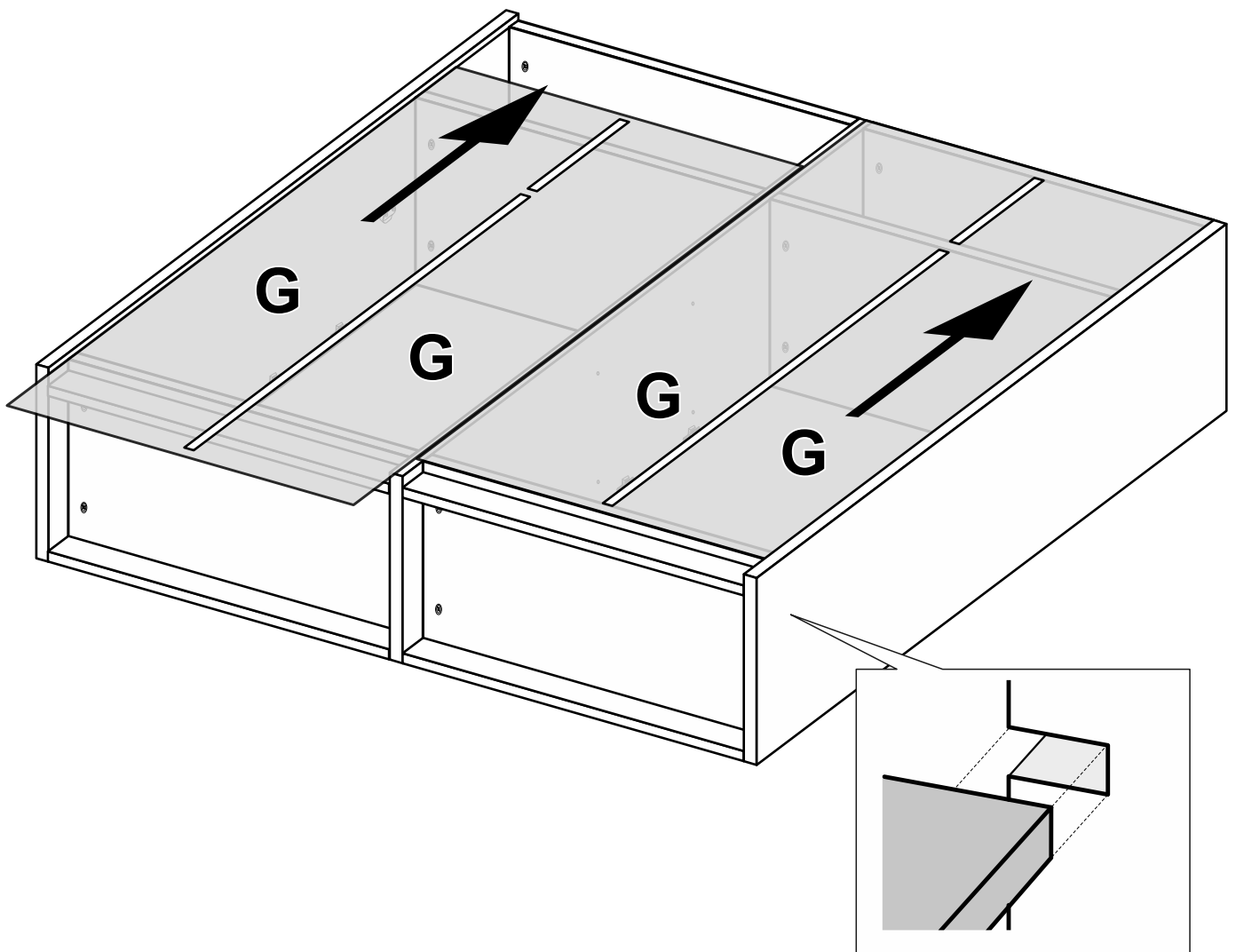
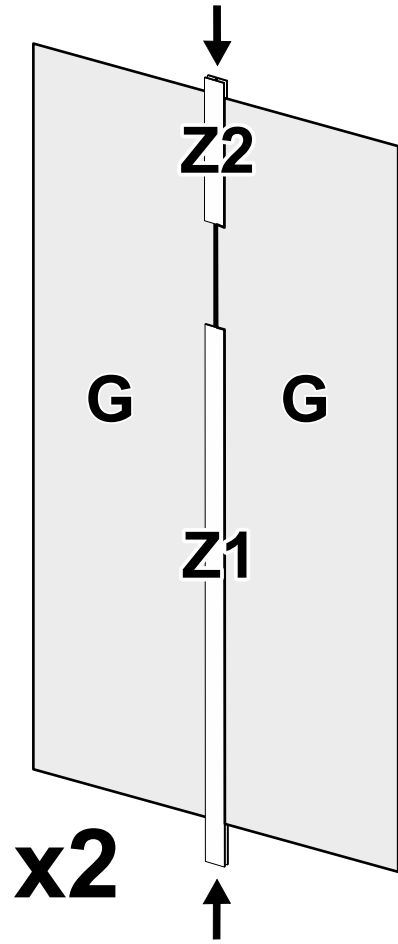

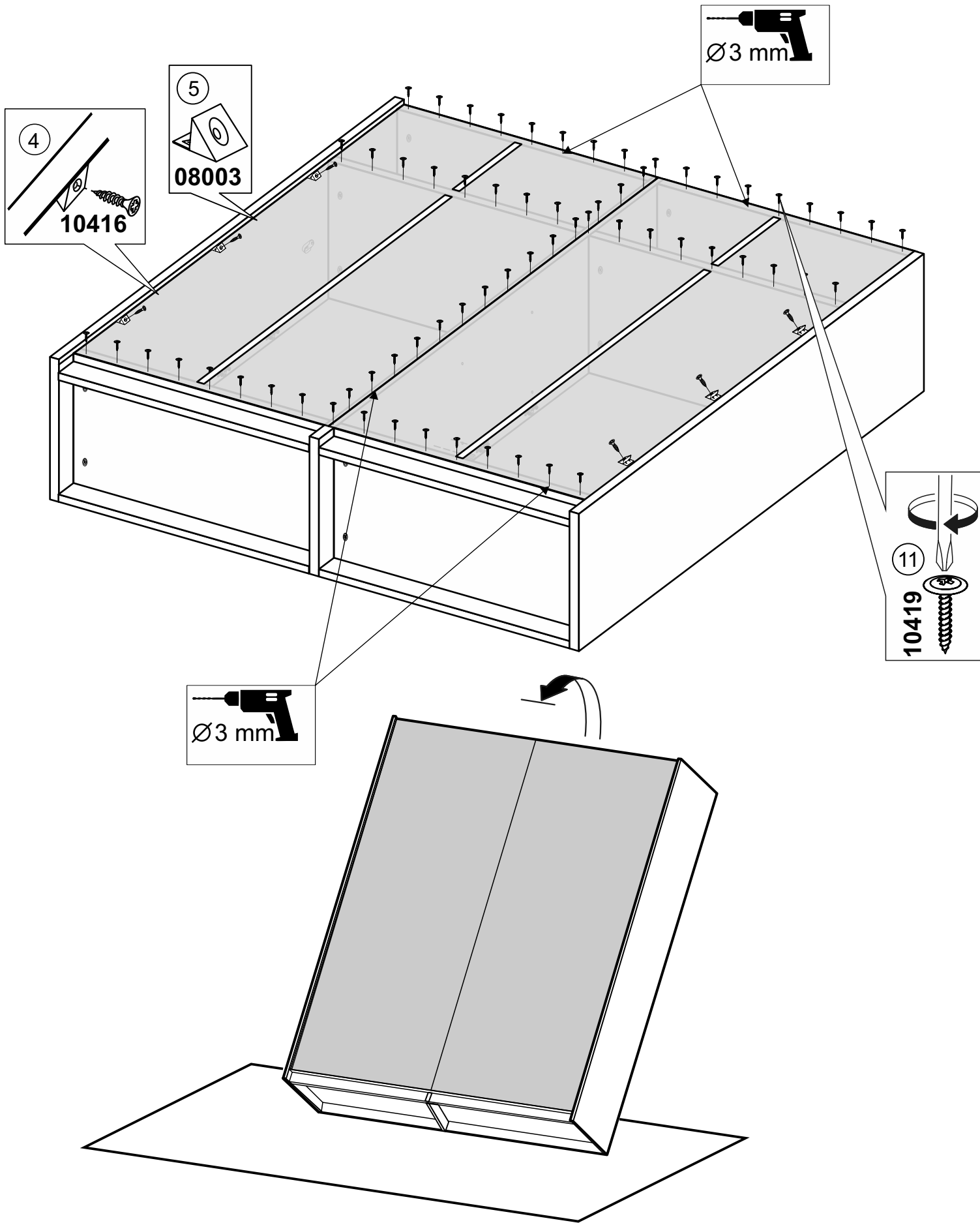

2
21008

9
11002

11
11016

