

# Szafa 200

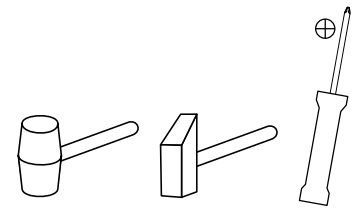

Nr	Nazwa elementu	D[mm]	S[mm]	G[mm]	Ilość
1	Bok L	2150	610	16	1
2	Bok P	2150	610	16	1
3	Wieniec Górny	1968	593	16	1
4	Wieniec Dolny	1968	610	16	1
5	Przegroda Pionowa	1676	470	16	2
6	Przegroda Mała	326	470	16	2
7	Przegroda Pozioma	1968	470	16	1
8	Półka	480	470	16	4
9	Cokół	1968	100	16	2
10	Listwa Maskująca	1968	70	16	1
11	Kapak	2015	992	2,5	2
12	Drzwi L	2005	1000	16	1
13	Drzwi P	2005	1000	16	1

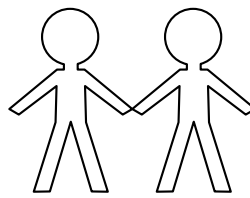
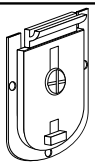
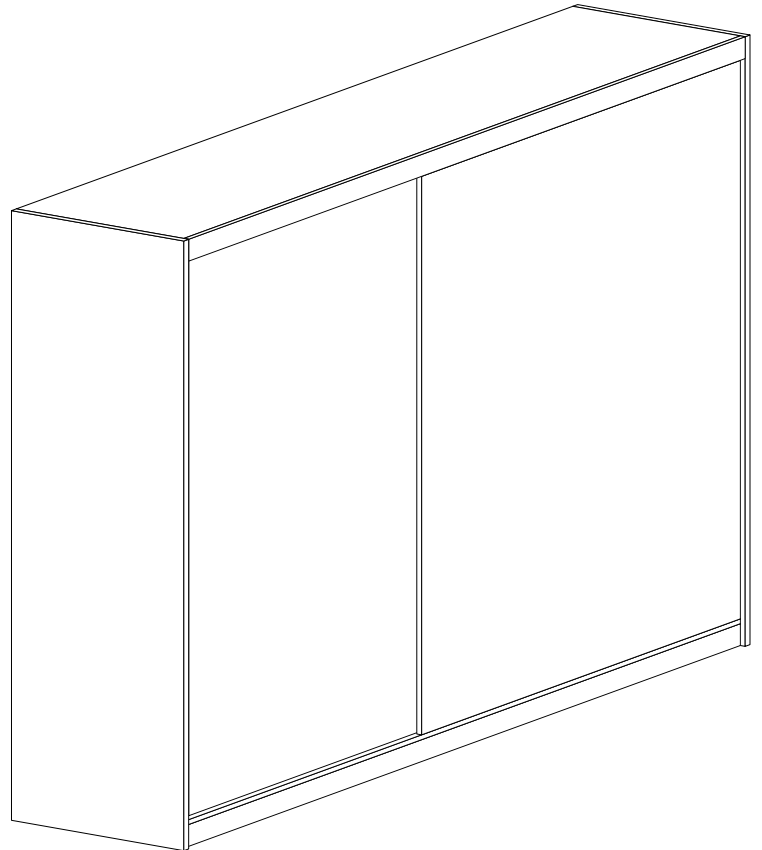

**A - 4 St.**

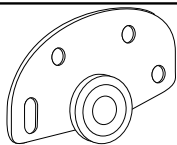

**B - 4 St.**

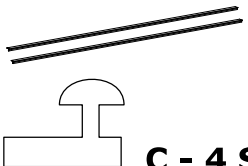

**C - 4 St.**

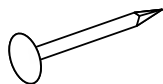

**D - 120 St.**

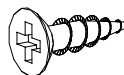

**E - 20 St.**  
2,5x10 mm



**F - 28 St.**  
3,5x16 mm



**G - 8 St.**  
3,5x16 mm

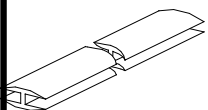

**H - 1 St.**



**I - 28 St.**



**J - 30 St.**

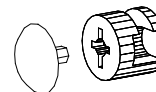

**K - 4 St.**

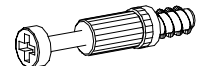

**L - 4 St.**

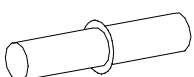

**M - 16 St.**

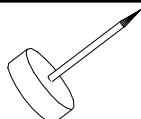

**N - 12 St.**



**O - 2 St.**

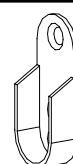

**P - 4 St.**



**R - 4 St.**

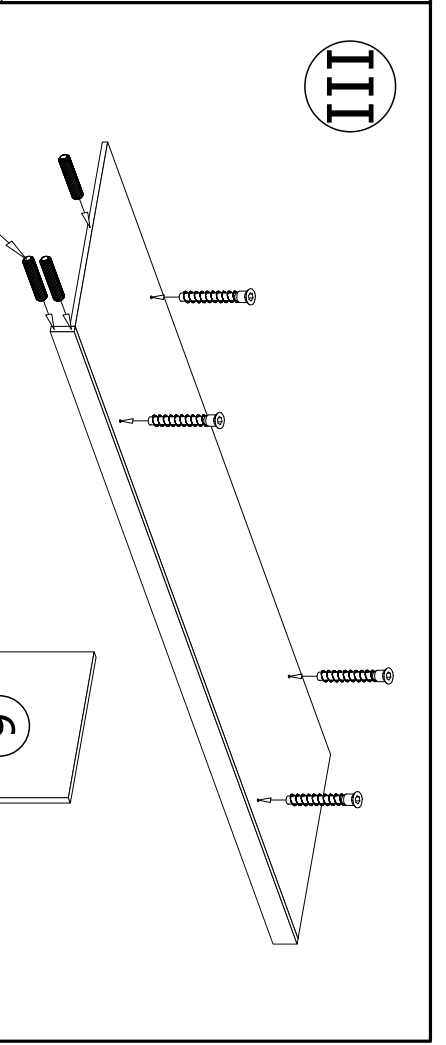
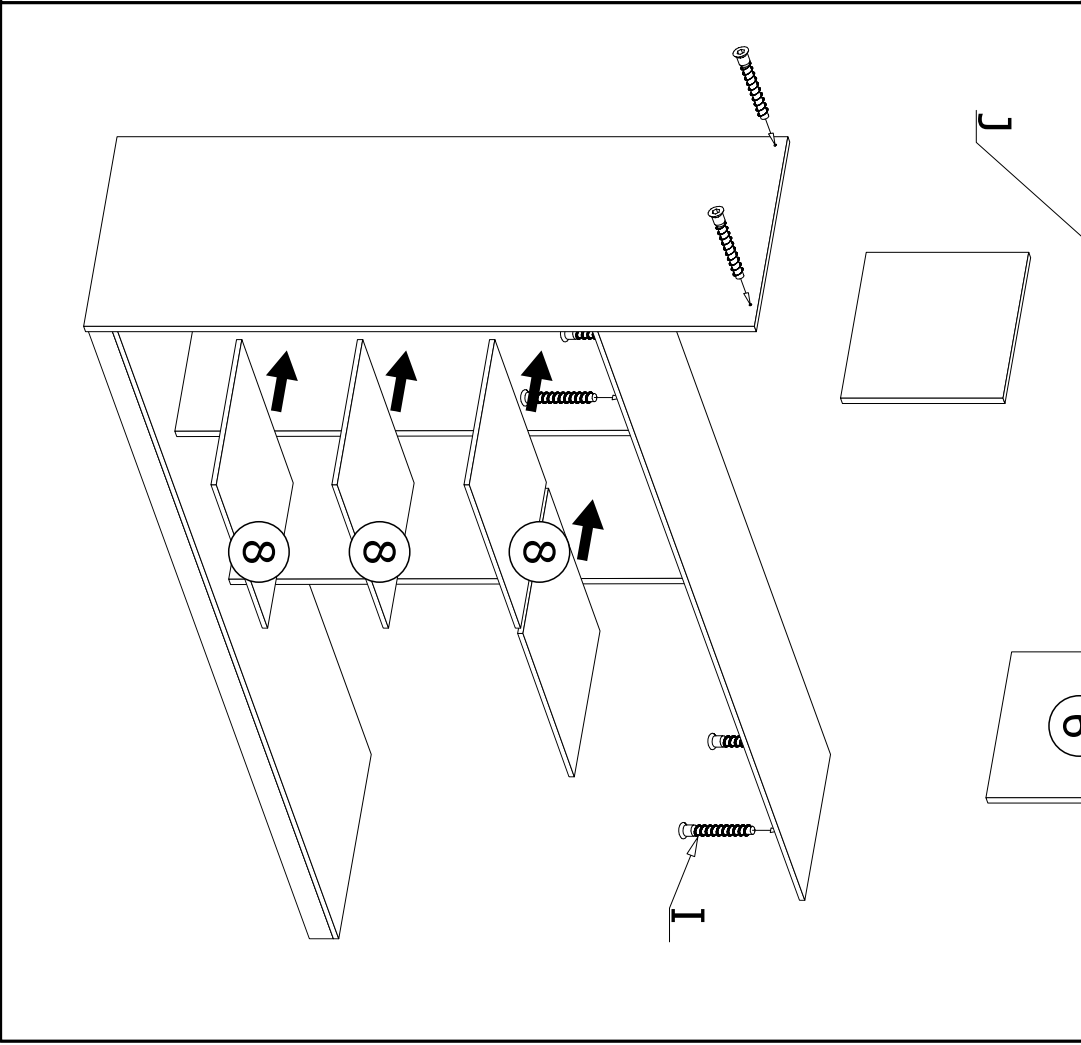
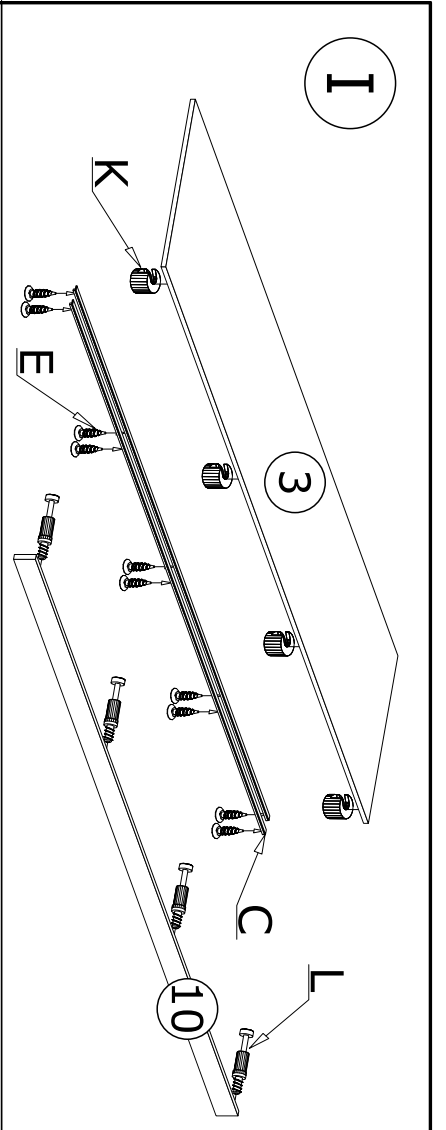
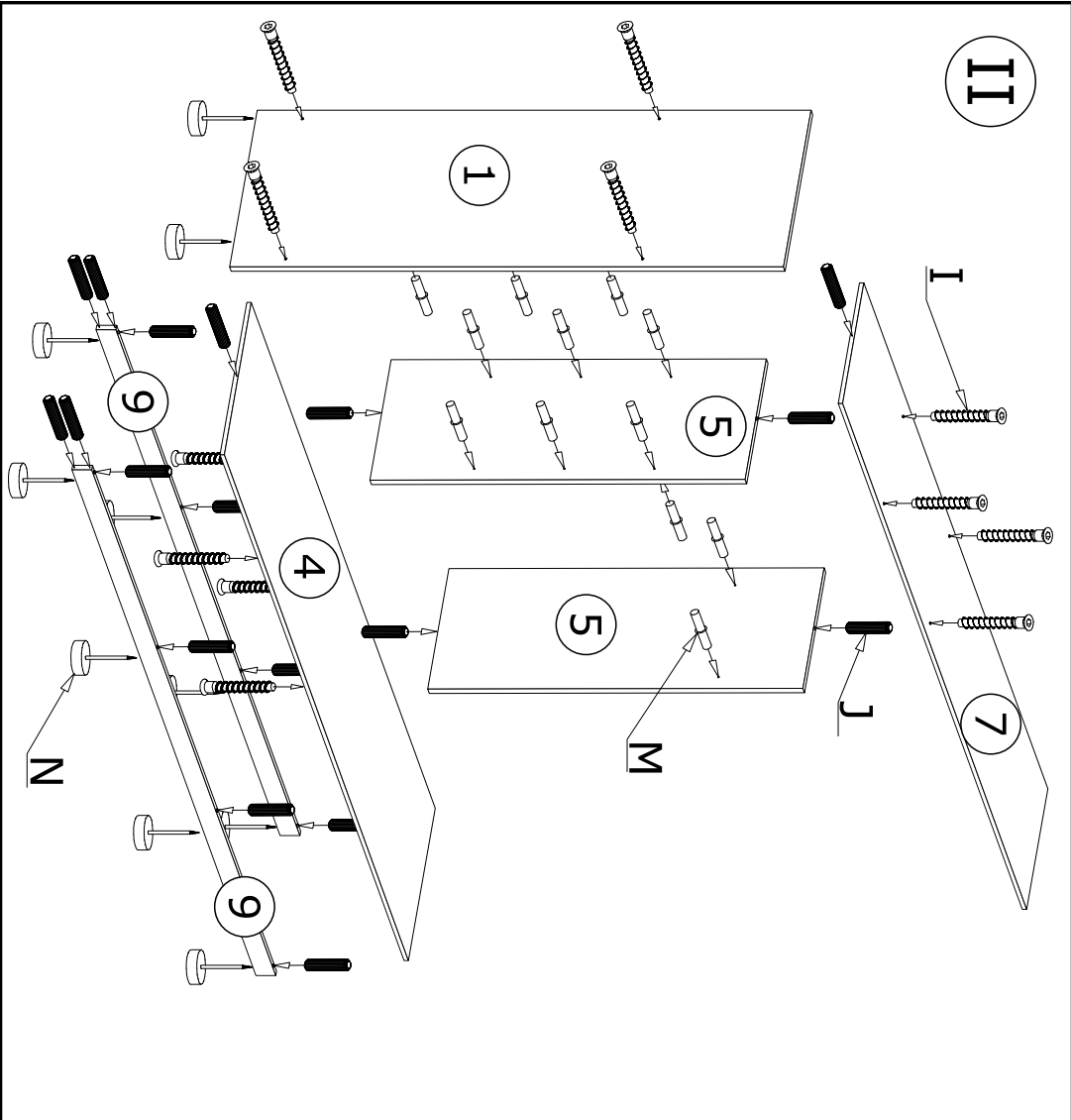

IV

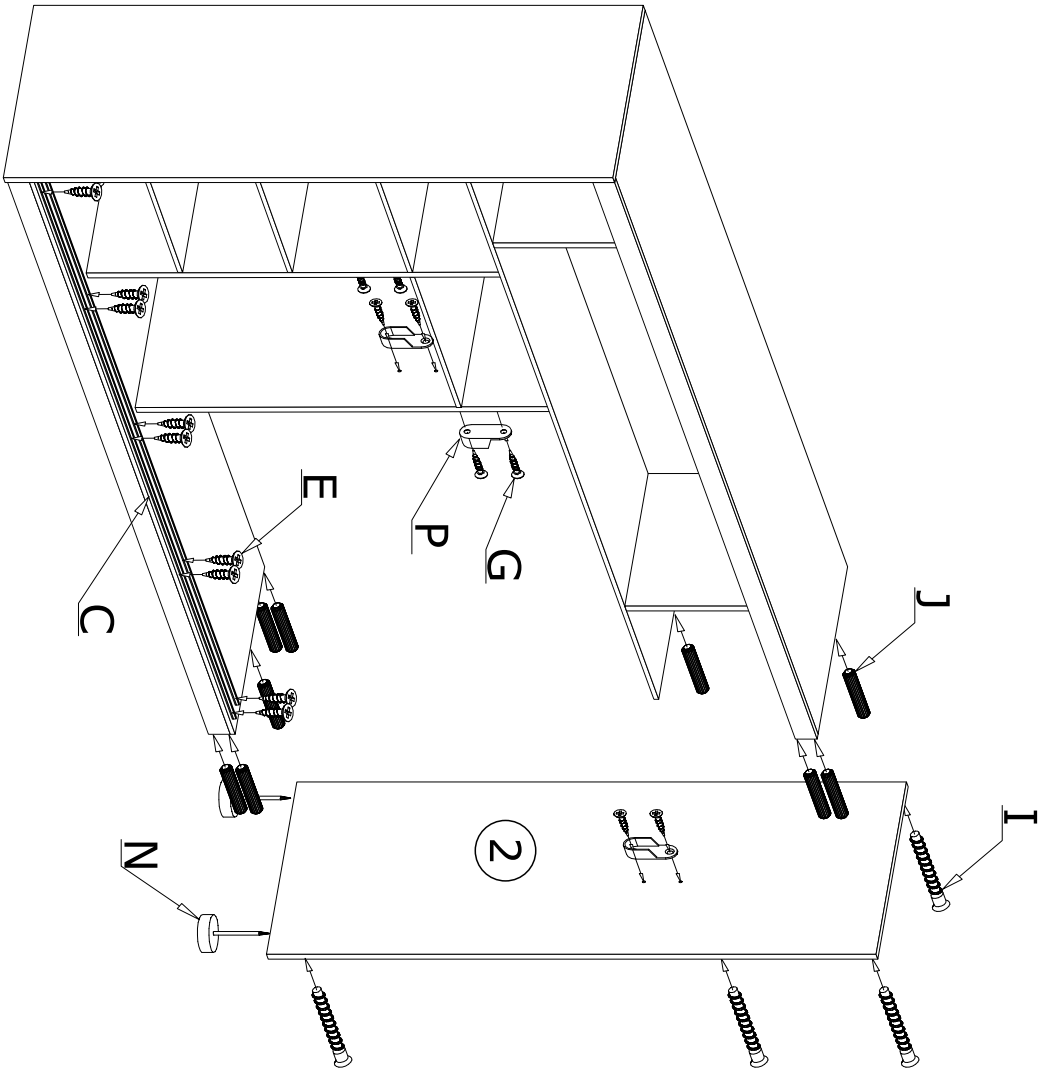

V

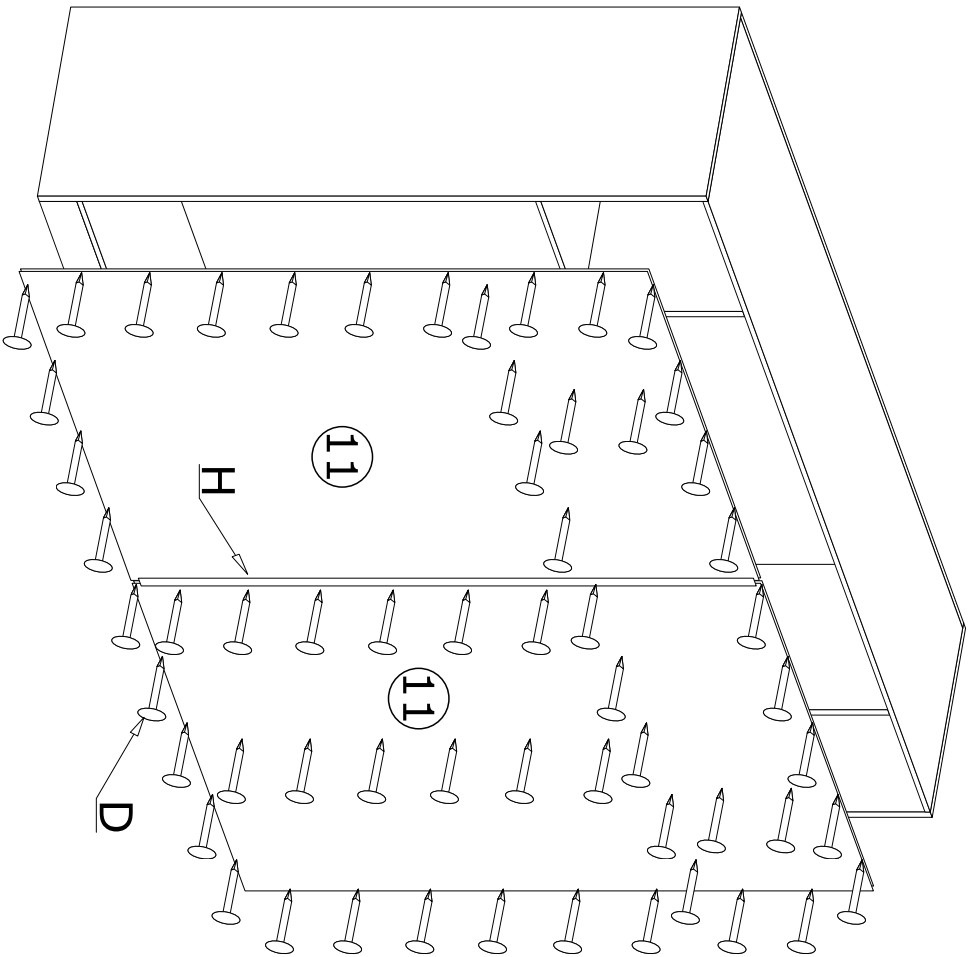

VI

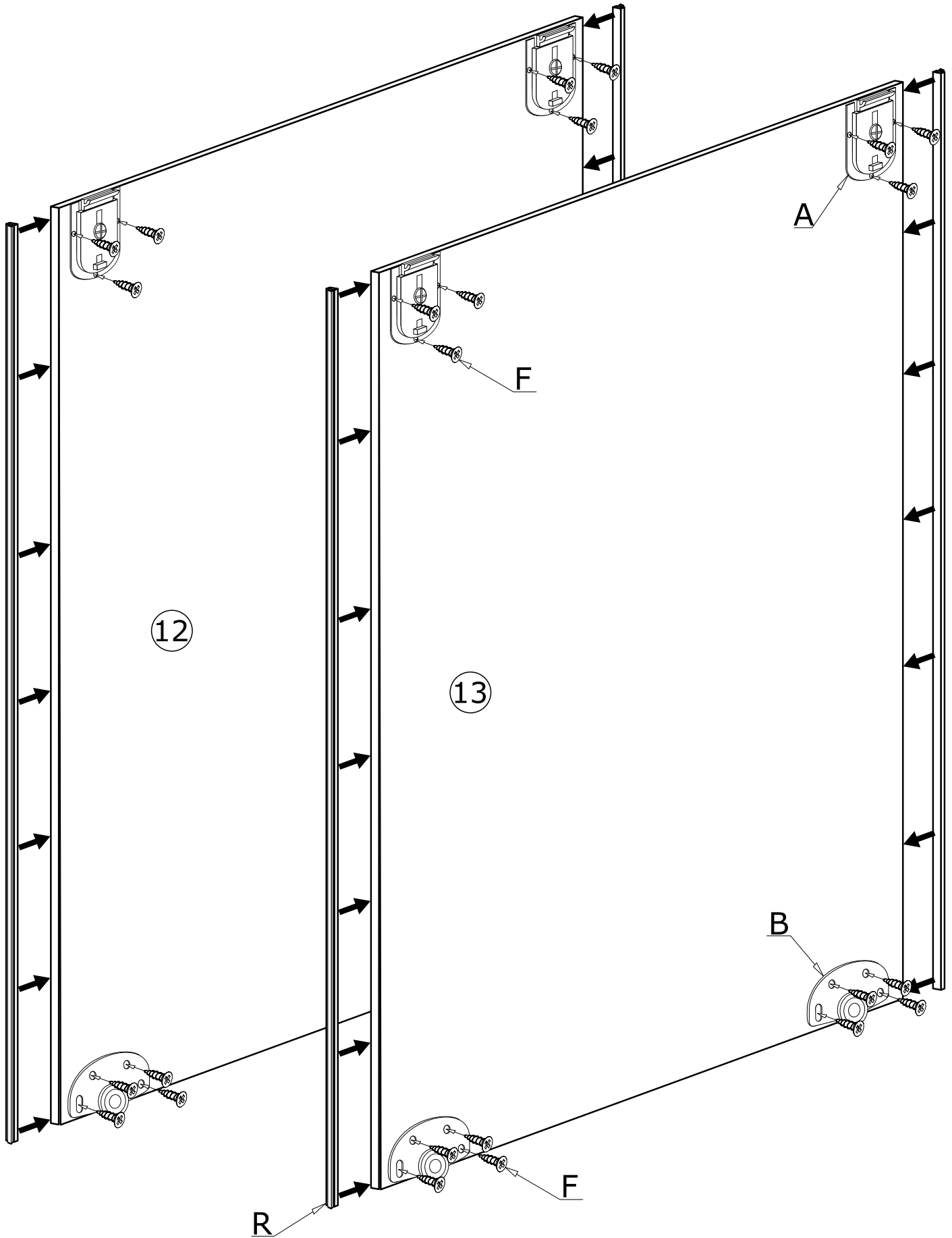

VII

