

(A1) x58	(C2) x 8 euro 6x13	(ZN) x4
(SP) x8	(W4) x8	(N1) x20
(M) x1	(O2) x 4	(KF) x10
(P1) x16 podpórka 5x11	(G4) x80 gwoździe	(T3) x 2 L=300
(F1) x18 ^T	(E1) x18 ø15x 12mm	x18

R-11

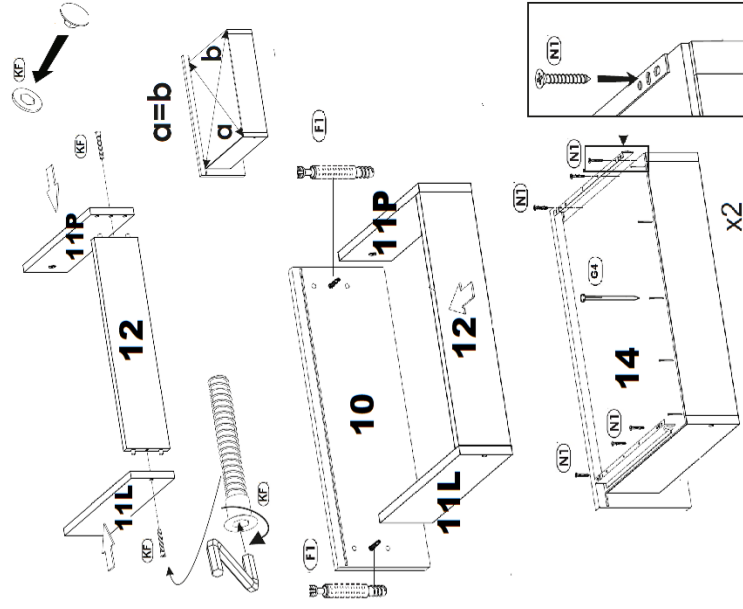

R-11

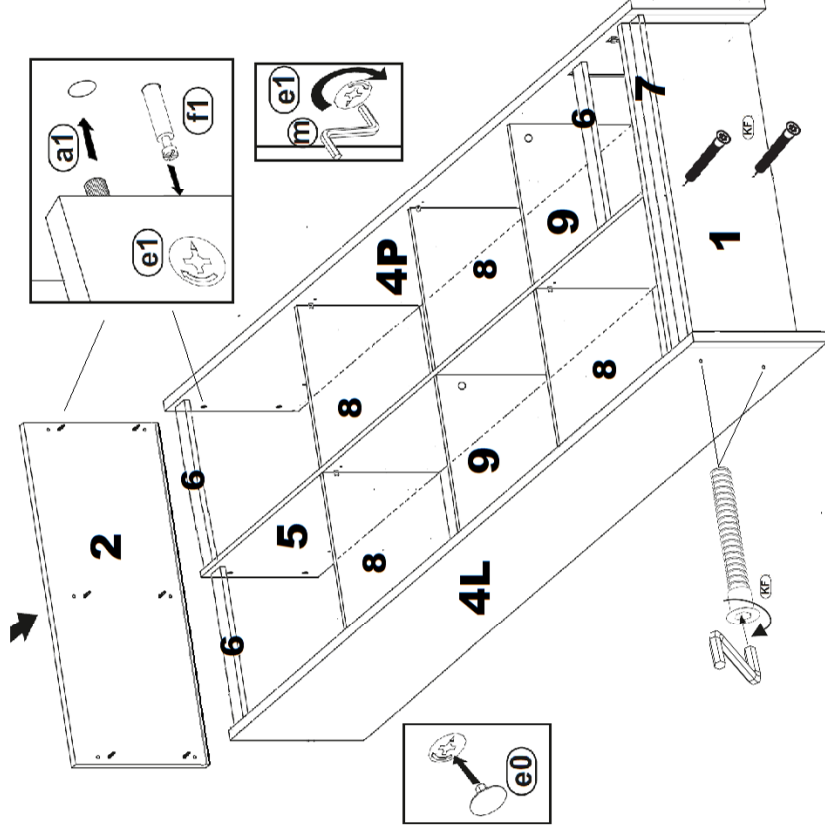
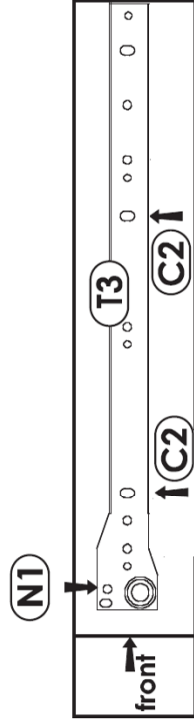
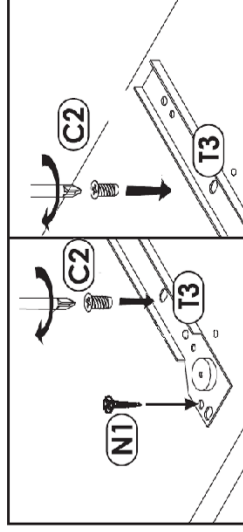
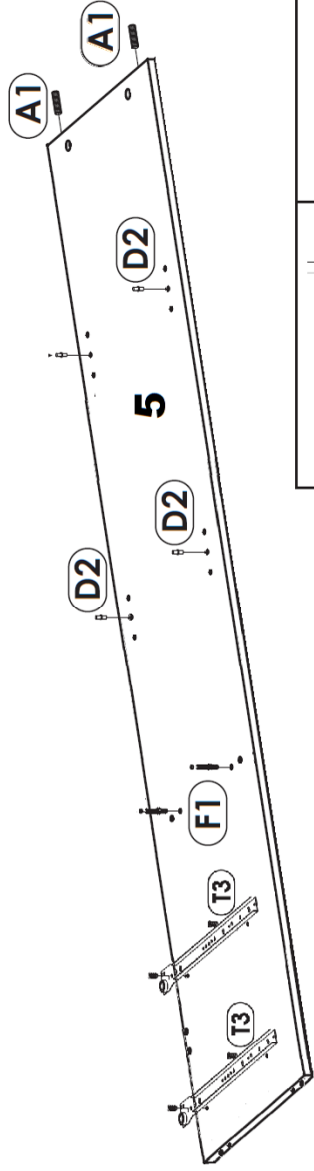
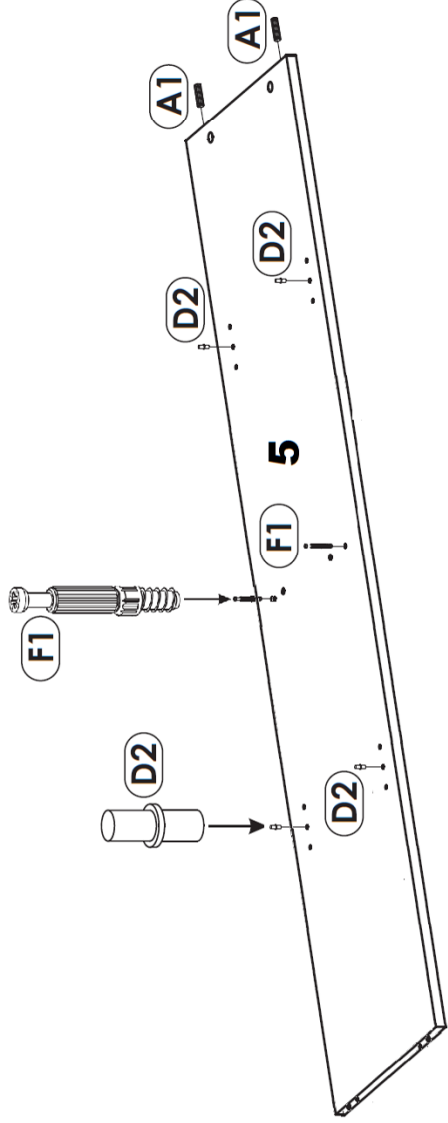
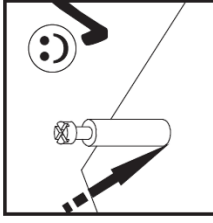
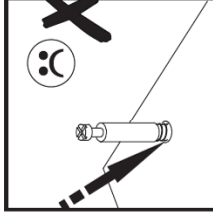
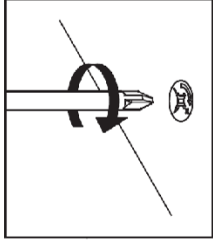
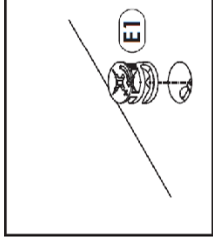
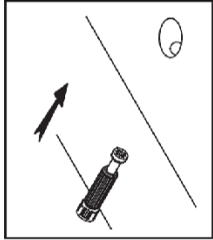
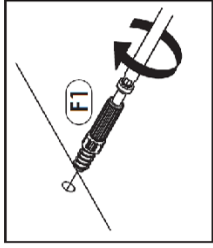
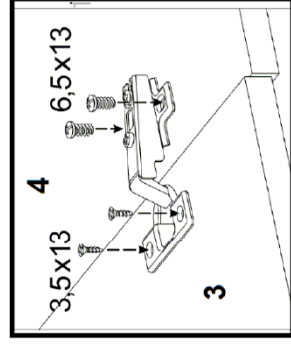
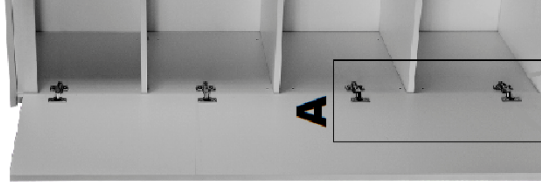
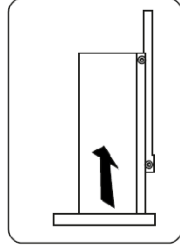
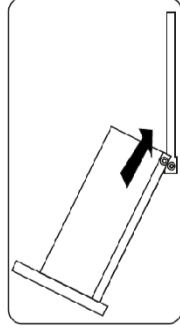

A

