

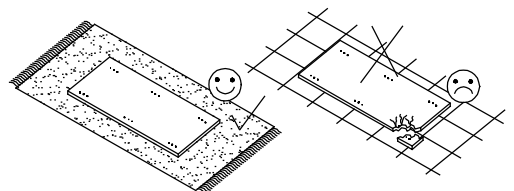

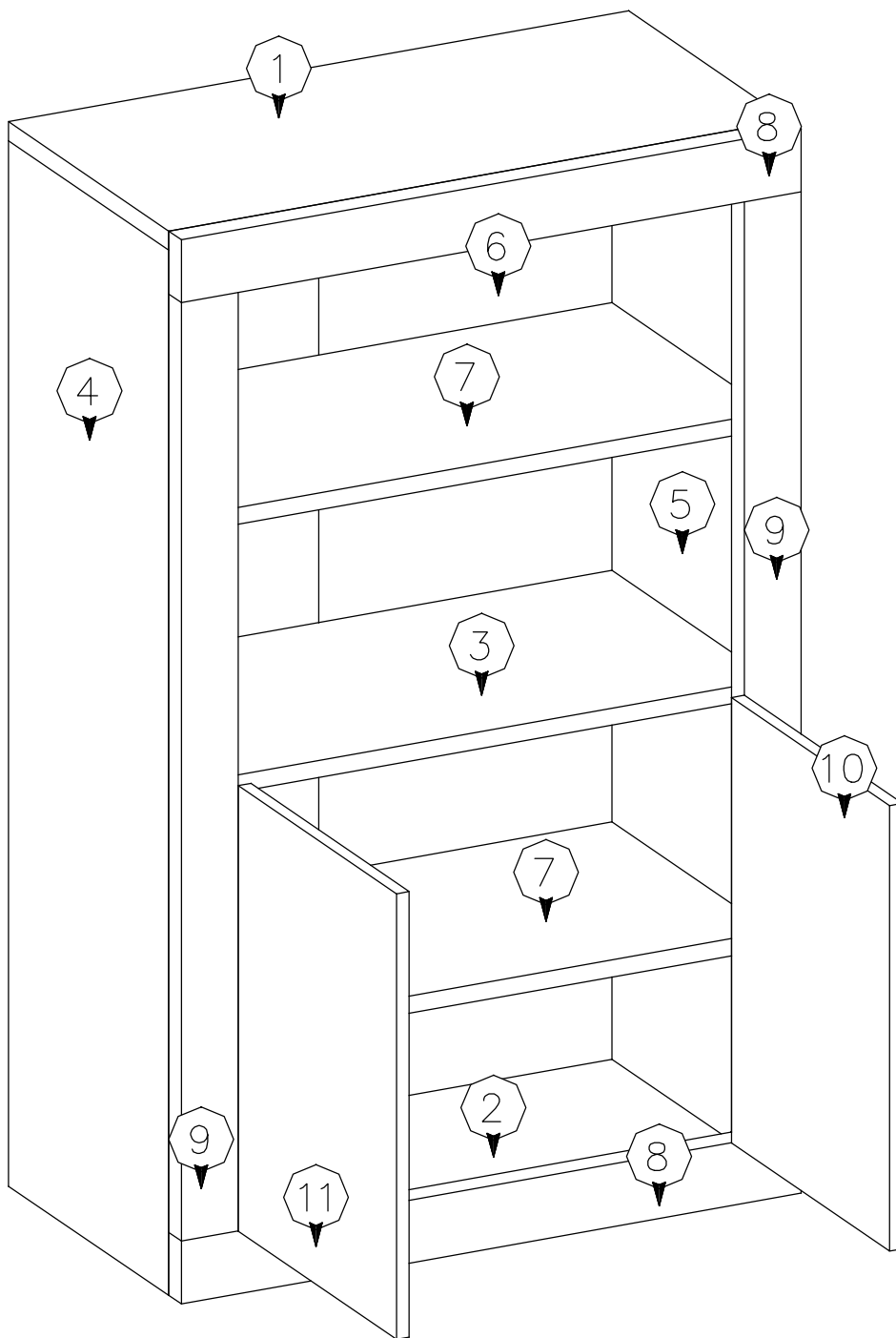













4mm







1	1
2	1
3	1
4	1
5	1
6	1
7	2
8	2
9	2
10	1
11	1

		8.0x35 					
8	1	12	8	20	4	40	
		4.0x13 				4.0x27 	
4	4	8	8	20	20	4	2



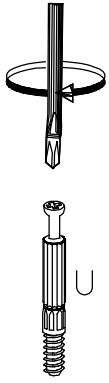
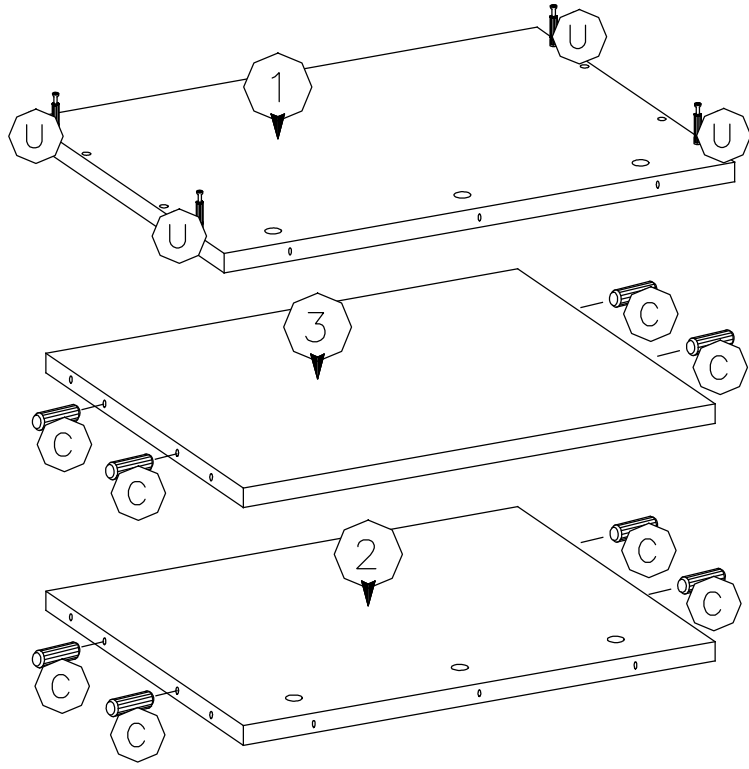

1

8.0x35		
	C	U
	8	4

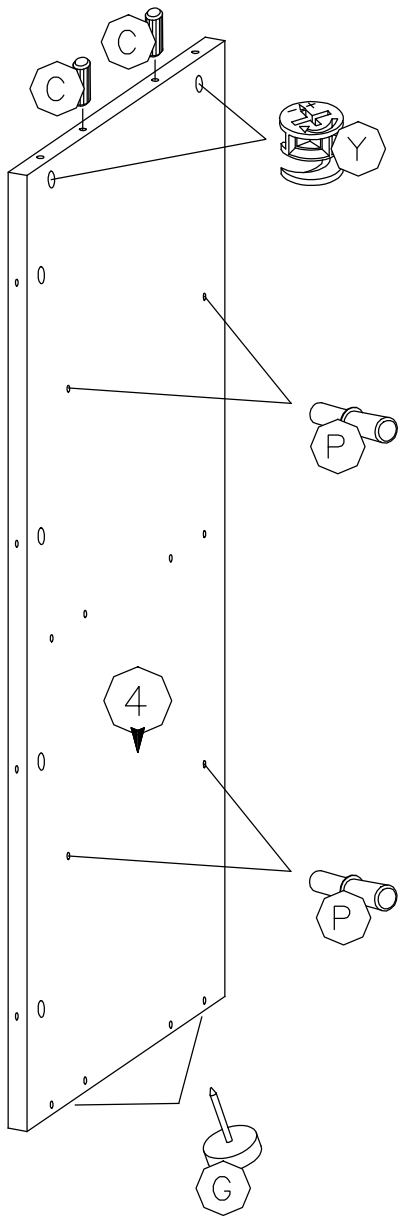

2



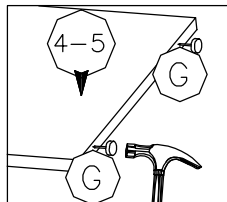
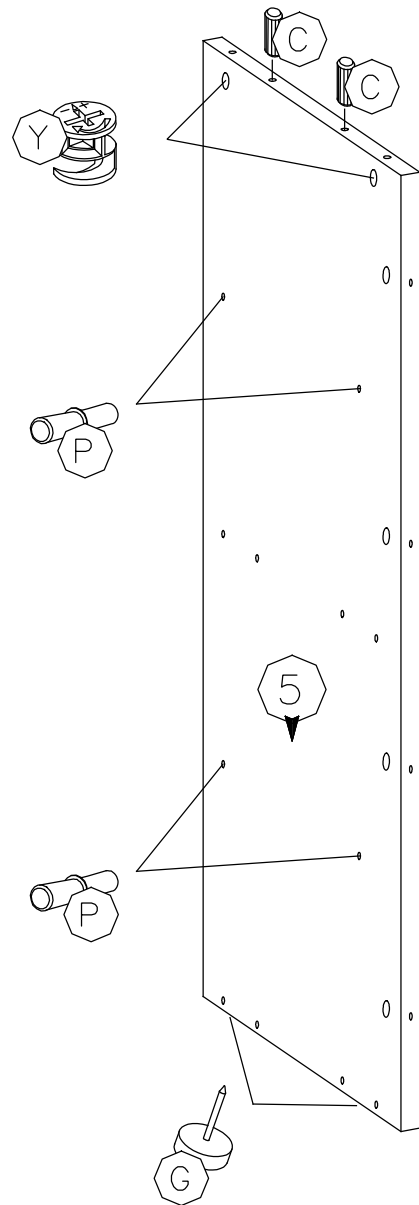

	
G	P
4	8
	
Y	C
4	4

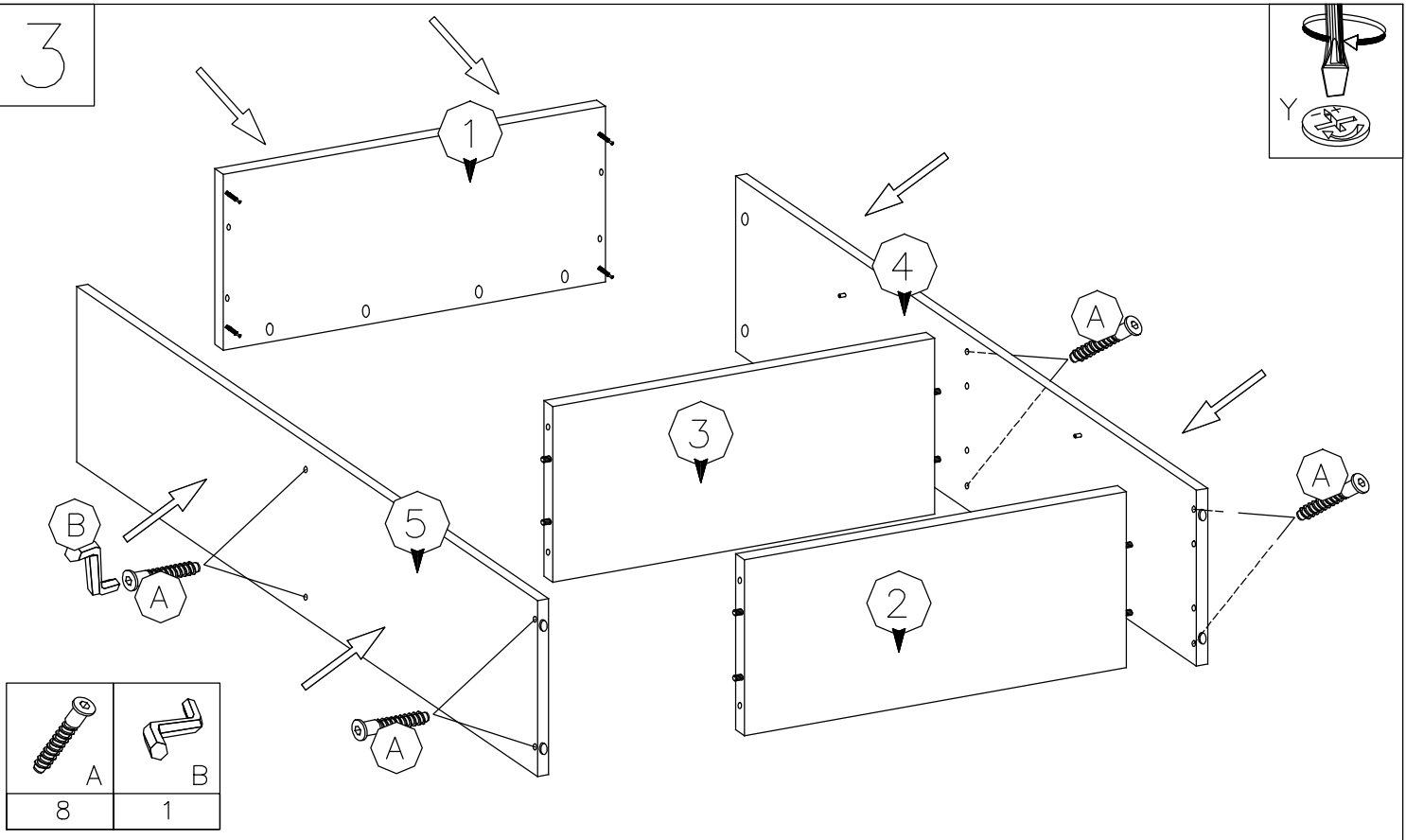
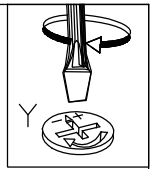

3

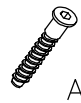

	
A	B
8	1



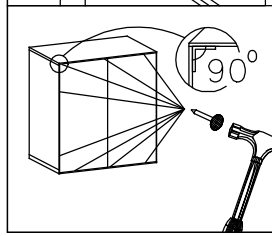
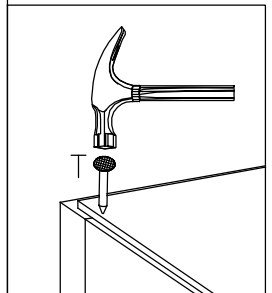
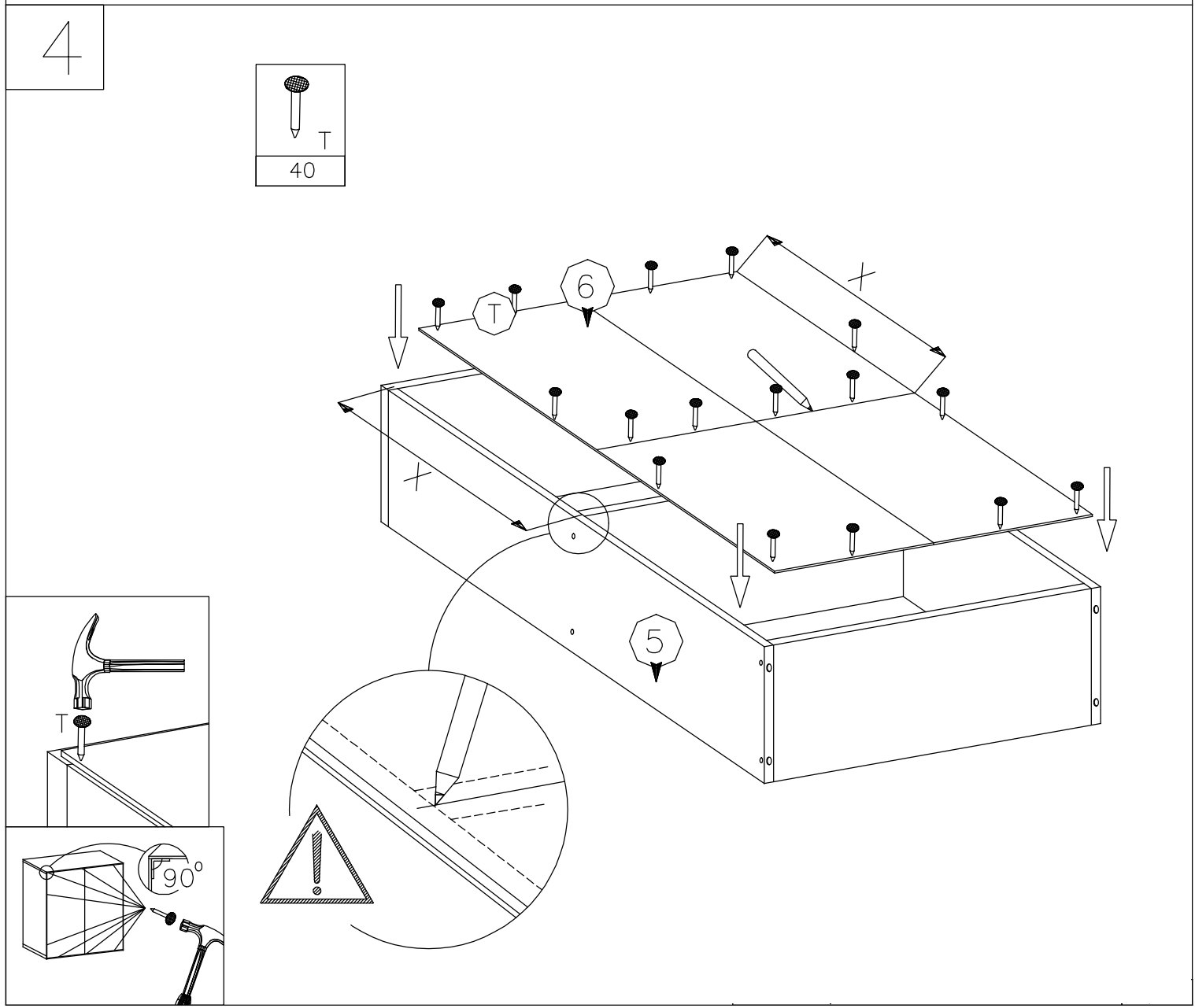
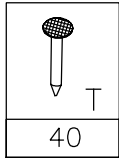

4

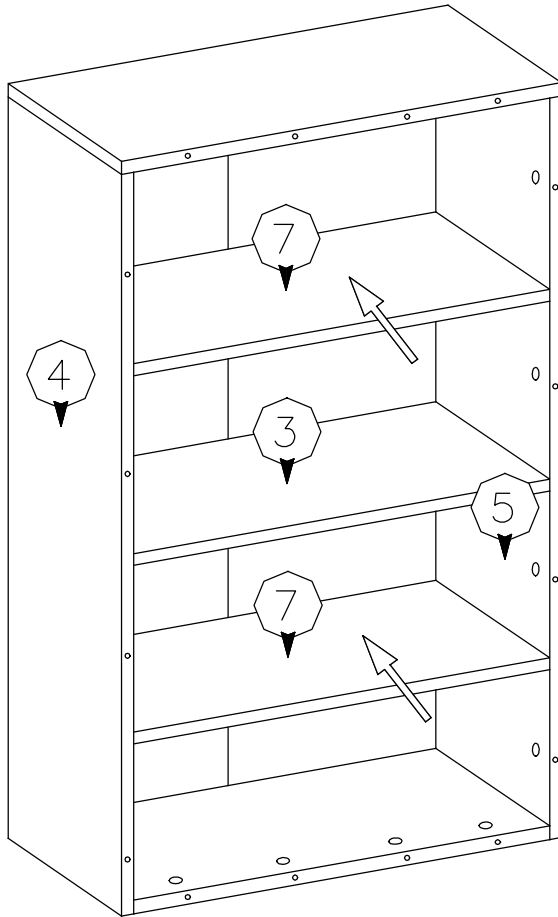

5



6

	4.0x13 	4.0x27 	
F	W	M	L
4	8	4	2

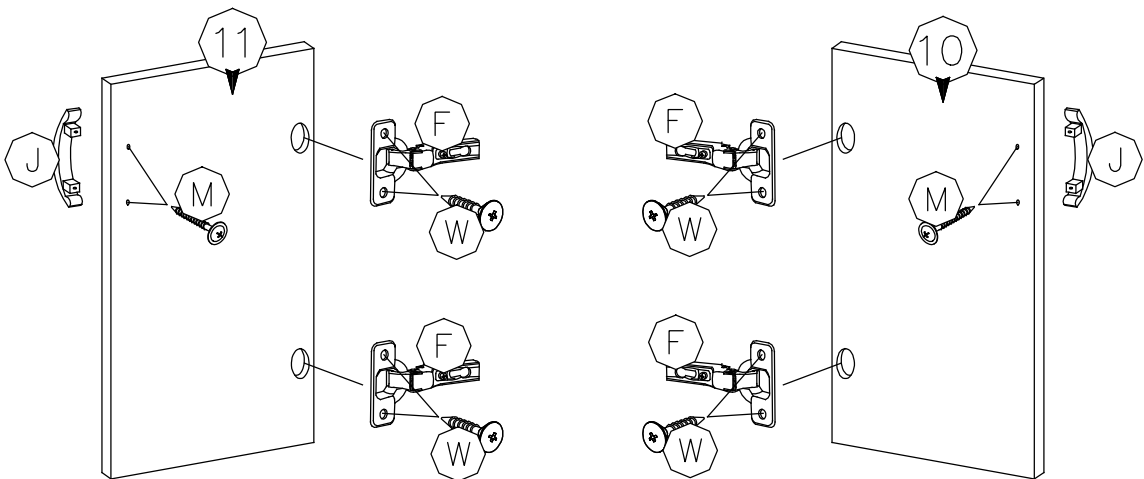

7

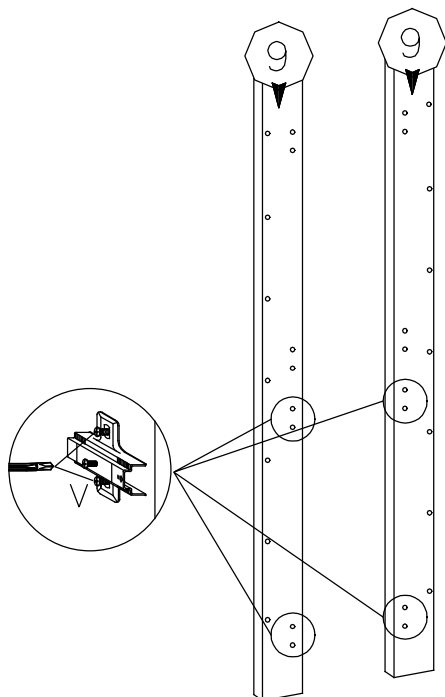
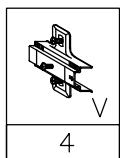

8

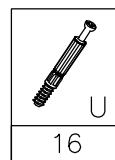
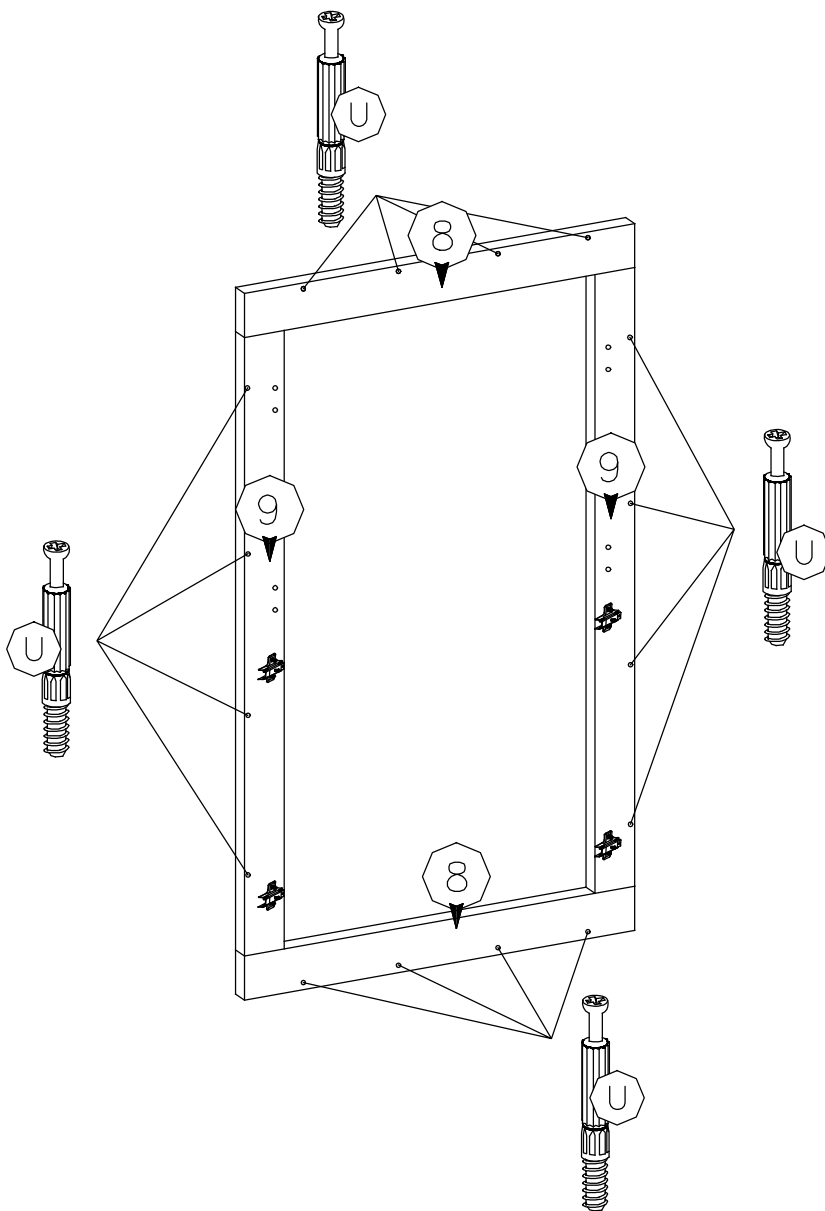

9

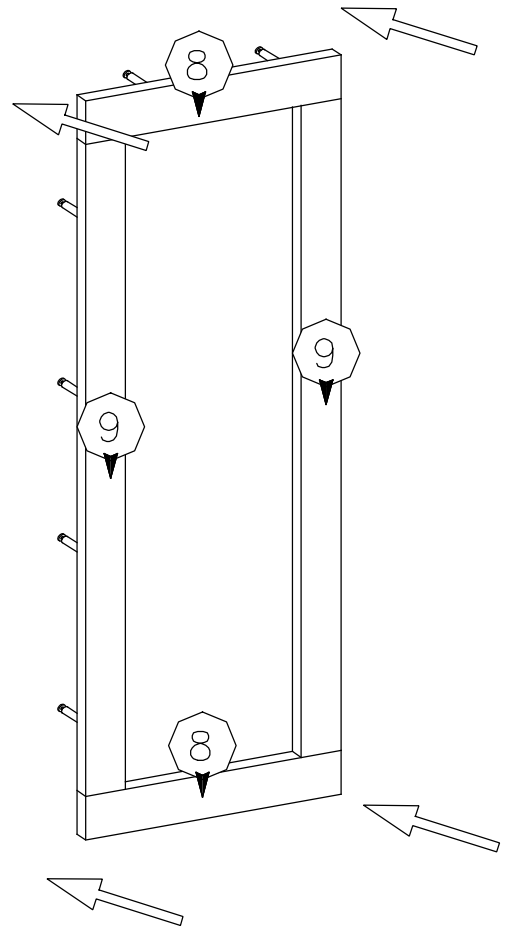
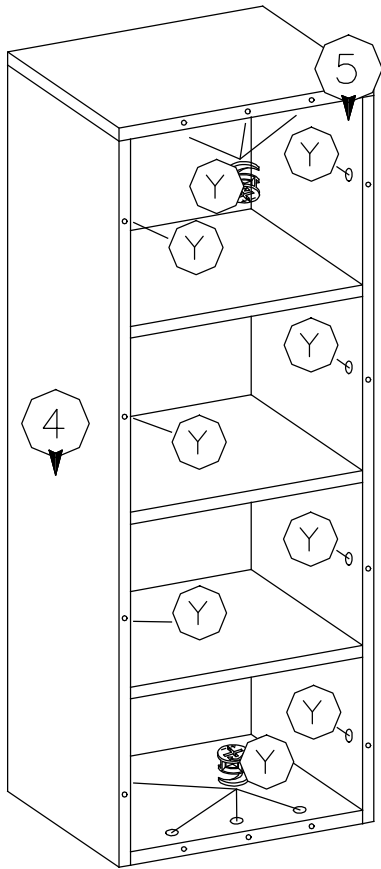
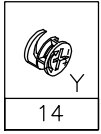

10

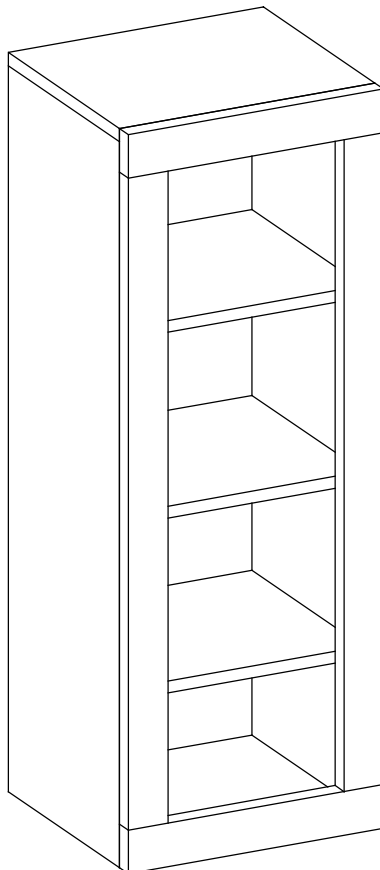
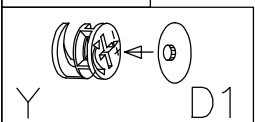
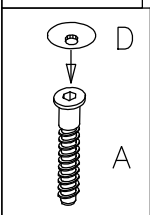
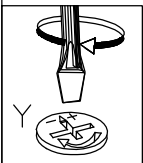
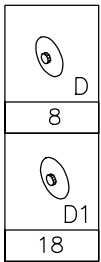

11

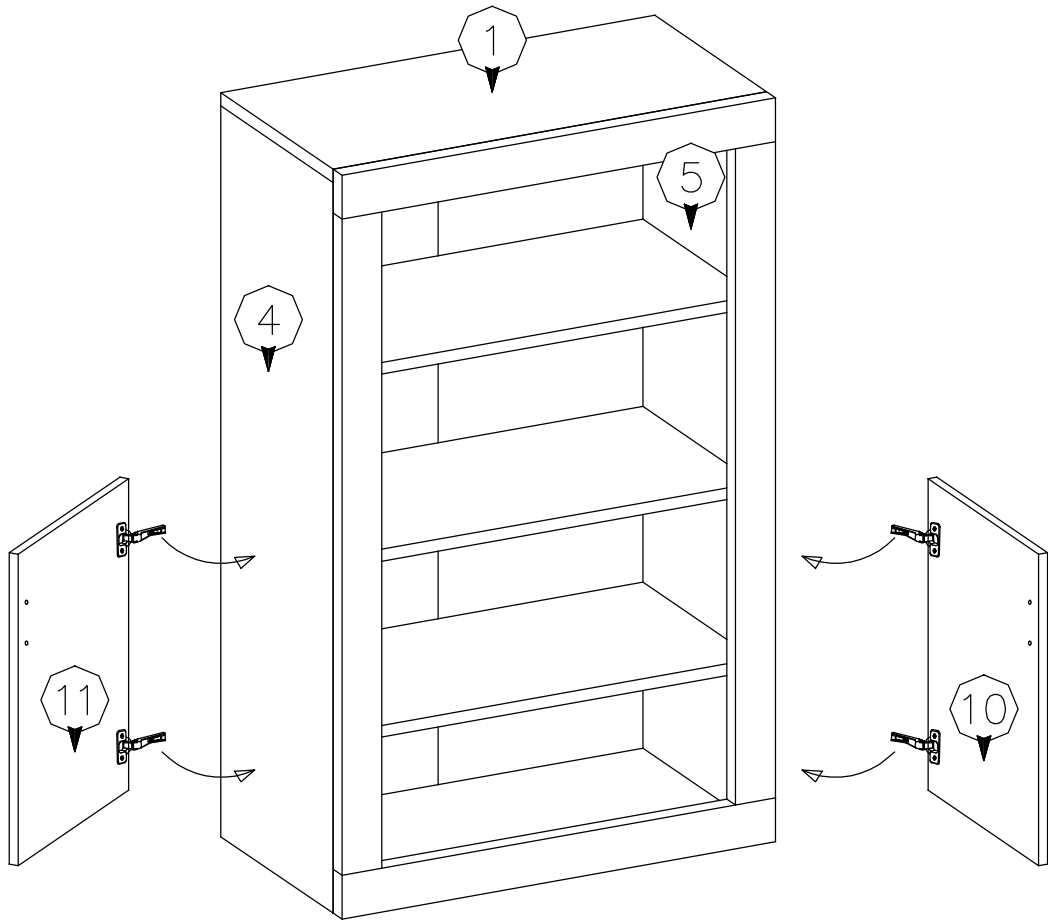

12

