

NWTF90

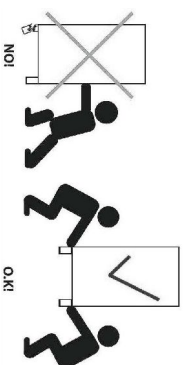

31.8.2017

- D** Montageanleitung
- FR** Notice de montage
- NL** Handleiding voor de montage
- CZ** Montážní návod
- HU** Szerelési útmutató
- TR** Montaj talimatı
- GB** Assembly Instructions
- IT** Istruzioni di montaggio
- PL** Instrukcja montażu
- SK** Návod na montáž
- RO** Instrucțiunile de montaj
- RU** Инструкции по монтажу

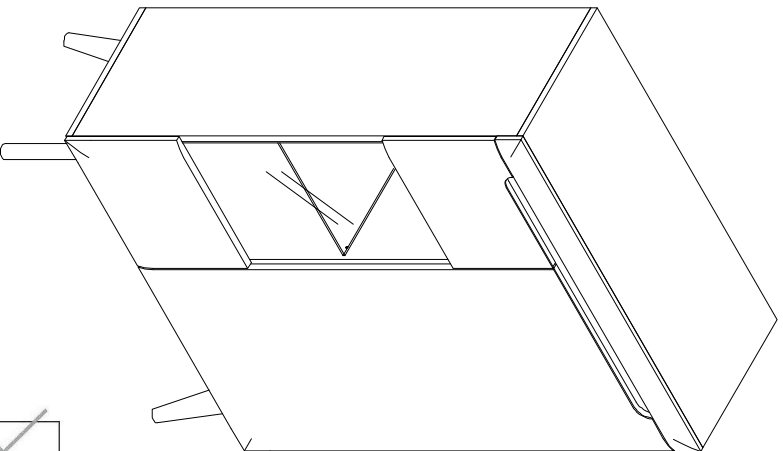
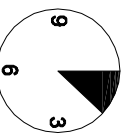
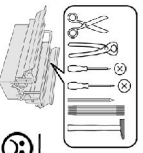

20 min.

1

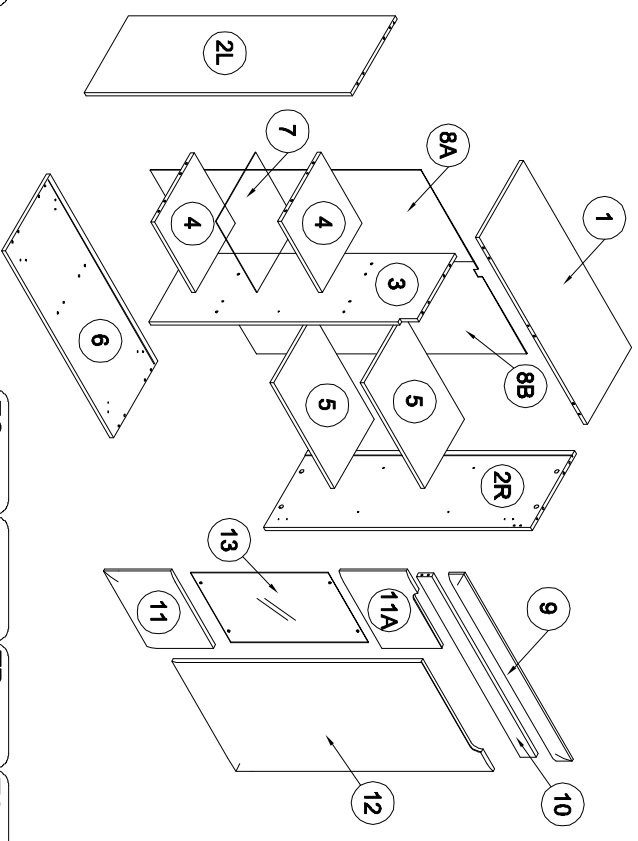

ZA x1	Z x23	HD x8	NGD x4	N x8	NA x1	TB x1	TA x1
B x23	A x27	H x10	R x5	PC x5	NC x4	ND x10	ZD x4
C x23	Z x23	HD x8	NGD x4	N x14	X x14	ZE x4	Z x8
B x23	A x27	H x10	R x5	PC x5	NC x4	ND x10	ZD x4

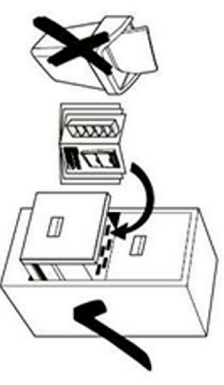
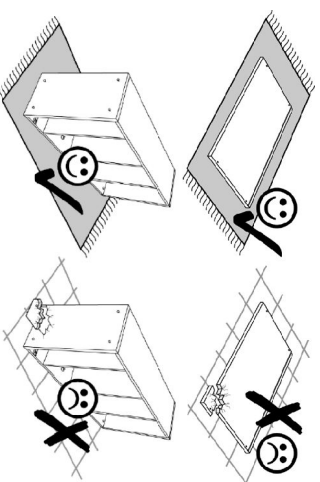

2

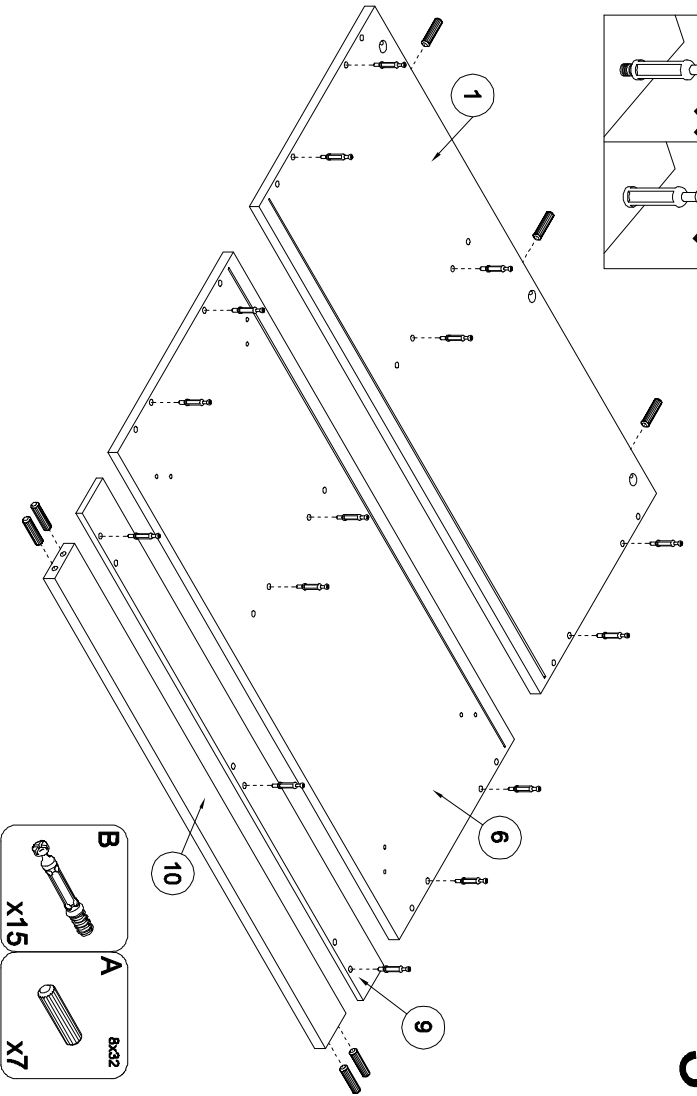
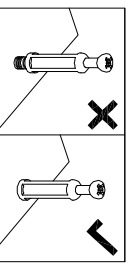

3

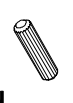
- | | |
|---|--|
| B | A |
|  |  |
| X15 | 8x32
X7 |

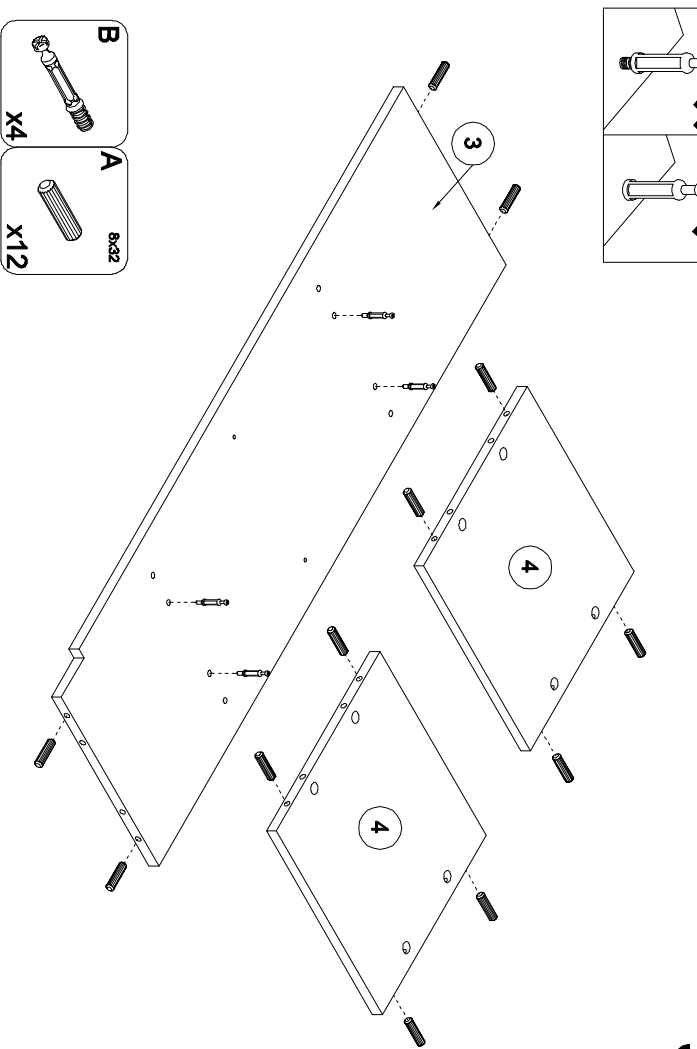
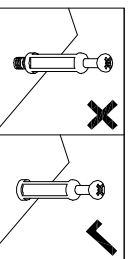



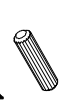

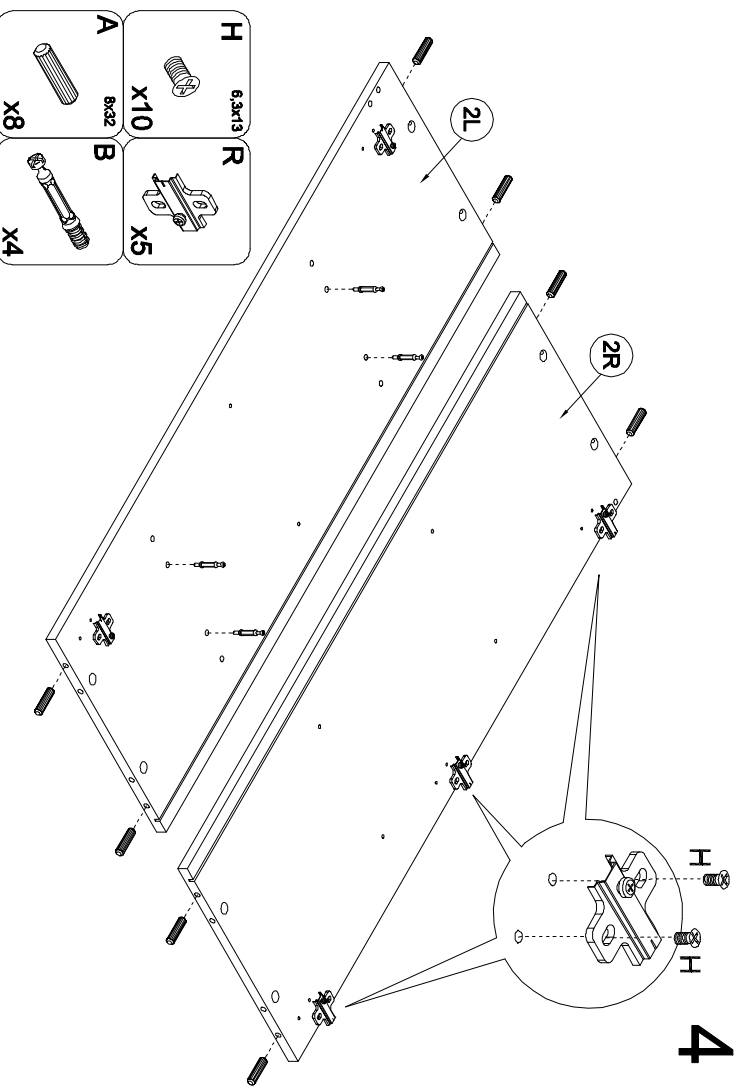
5

- | | |
|---|---|
| B | A |
|  |  |
| X4 | 8x32
X12 |





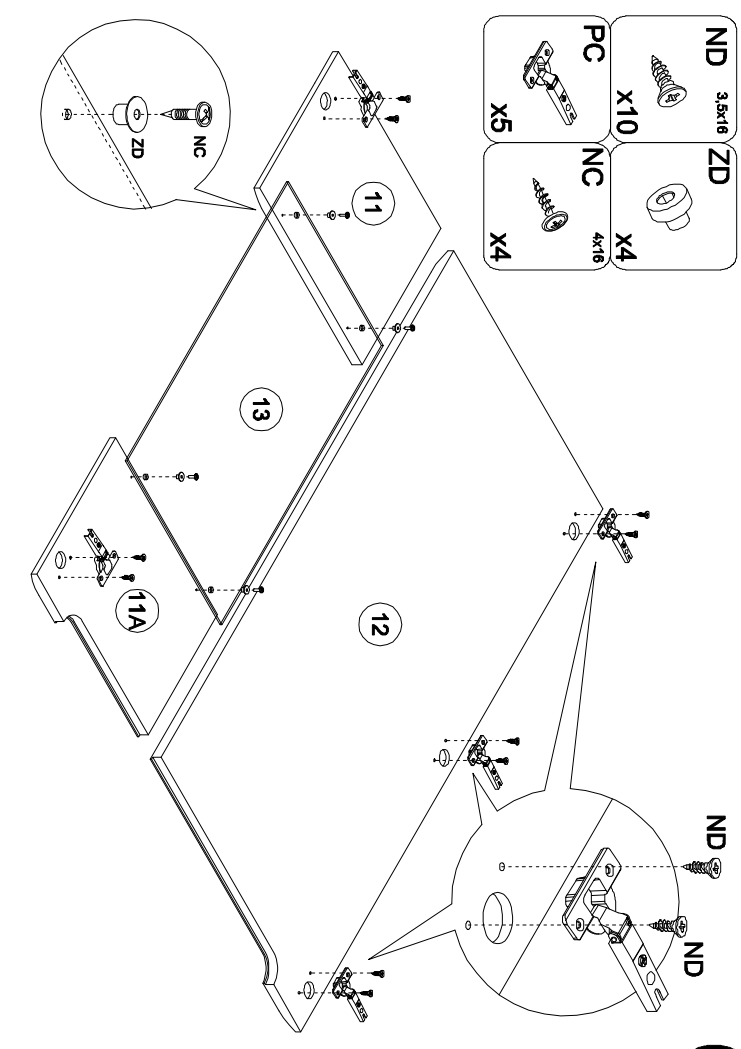

4

- | | |
|--|---|
| H | R |
|  |  |
| 6.3x13
X10 | X5 |
| A | B |
|  |  |
| 8x32
X8 | X4 |

6



6

- | | |
|---|---|
| ND | ZD |
|  |  |
| 3.5x16
X10 | X4 |
| PC | NC |
|  |  |
| X5 | 4x16
X4 |

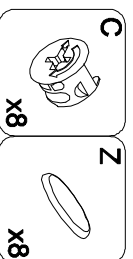
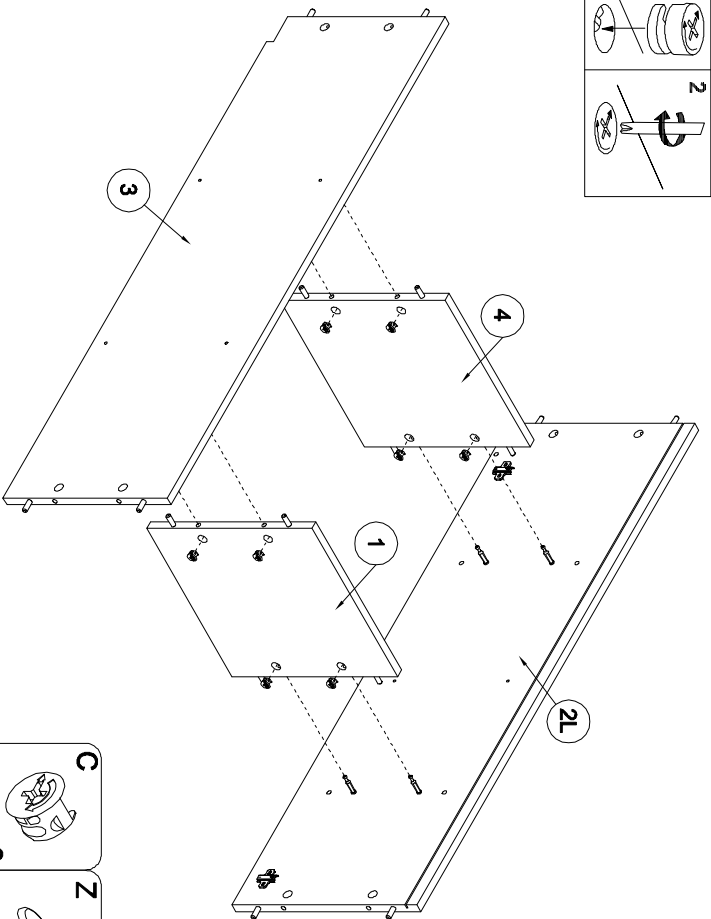
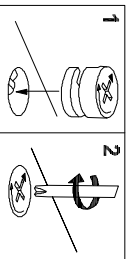

7

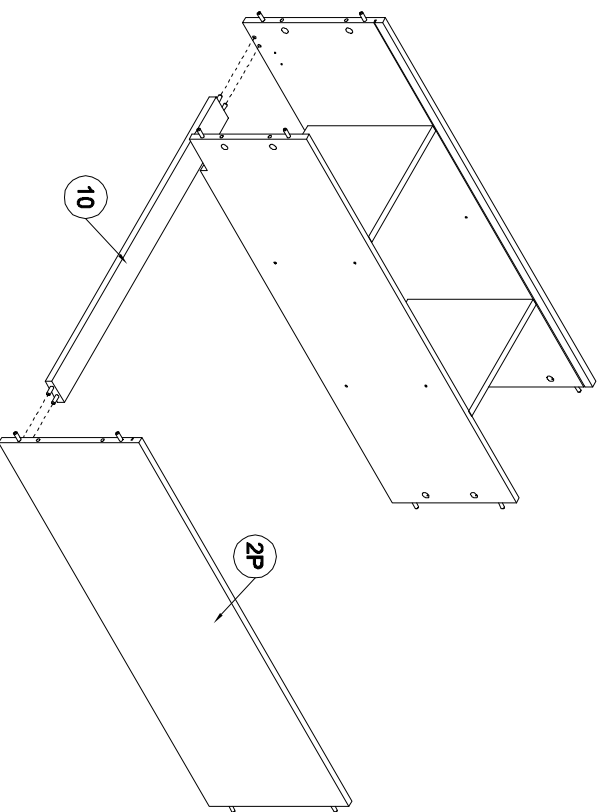

8

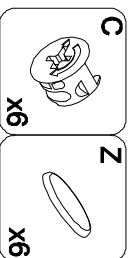
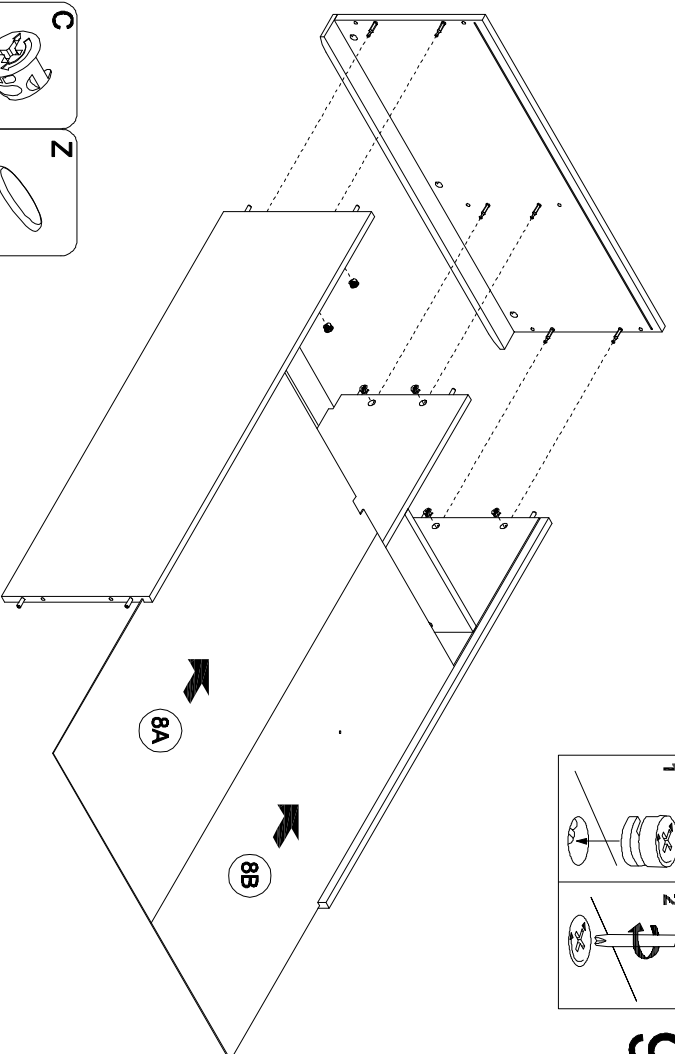
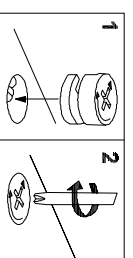

9

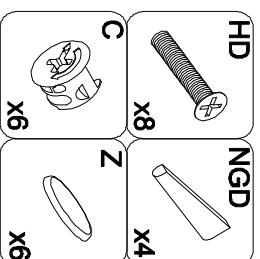
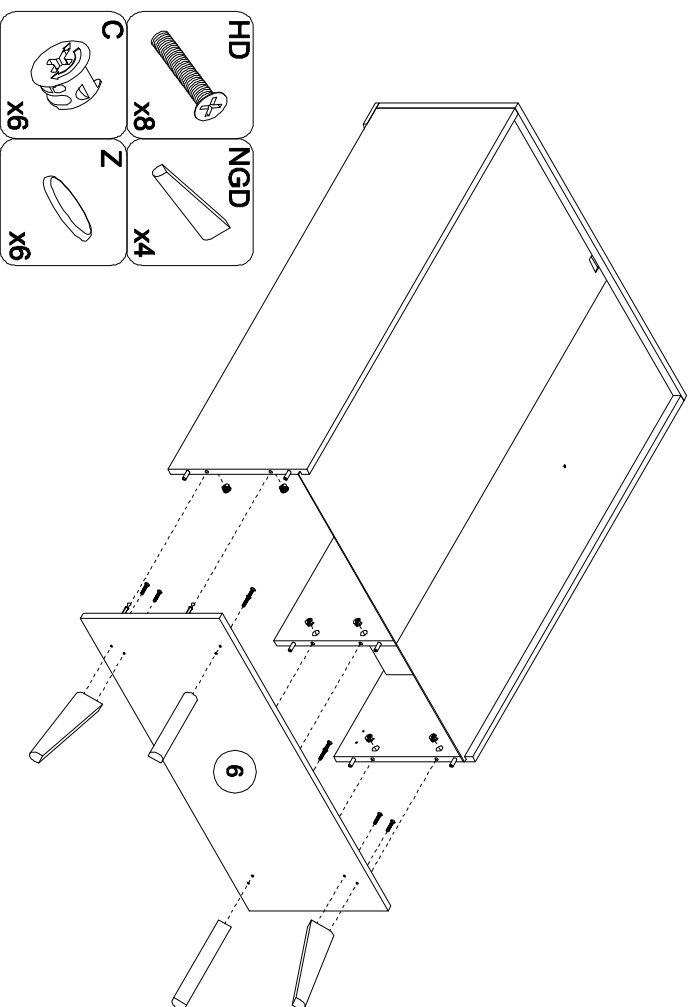

10

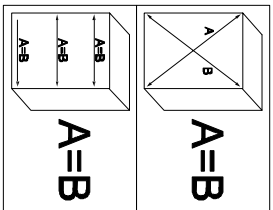

11

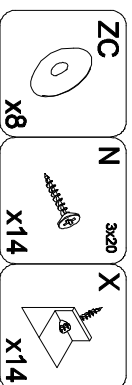
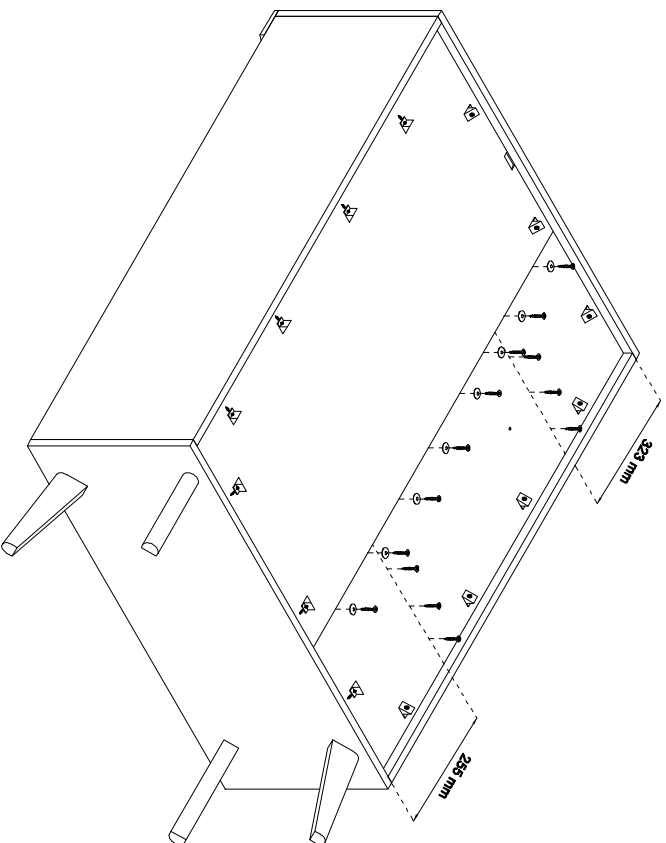

12

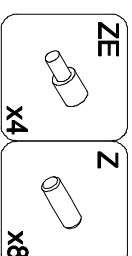
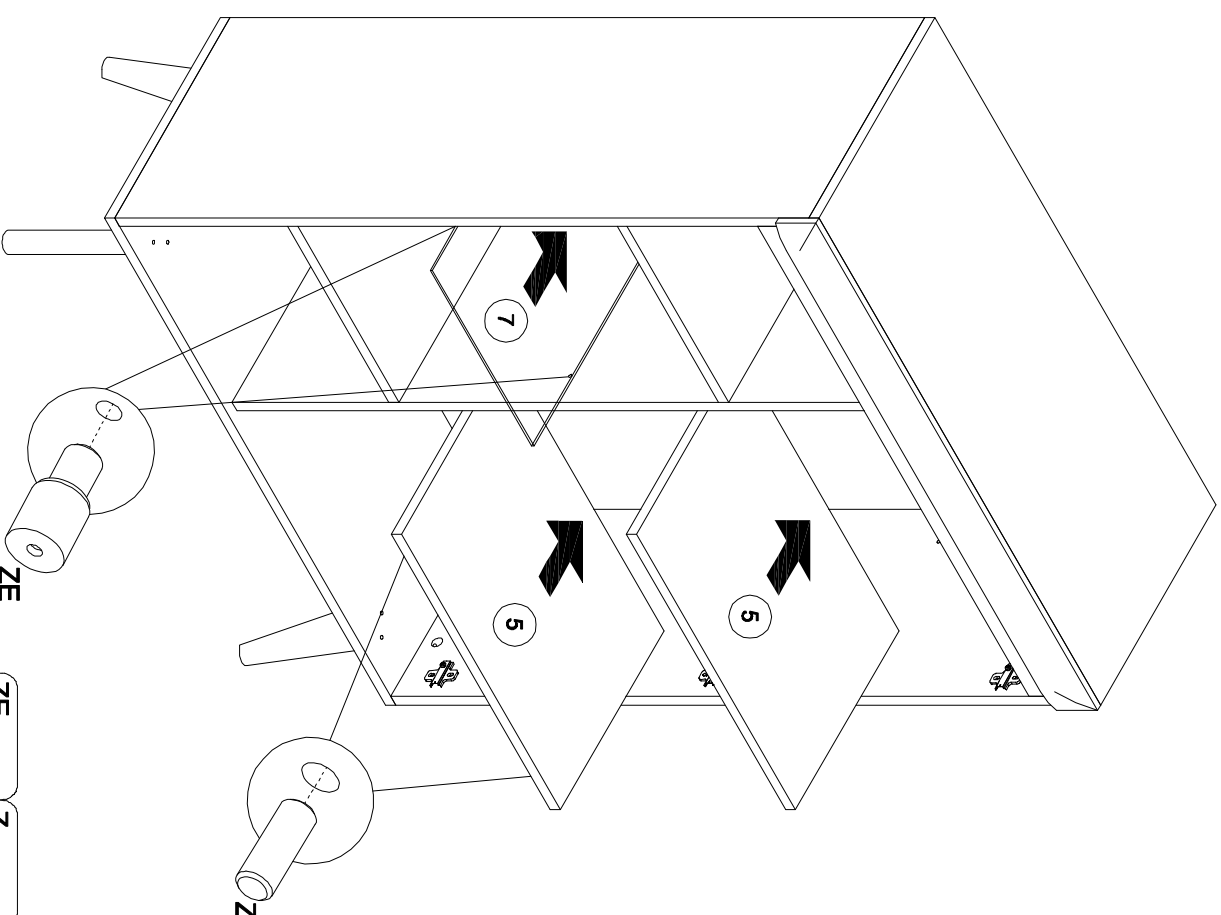

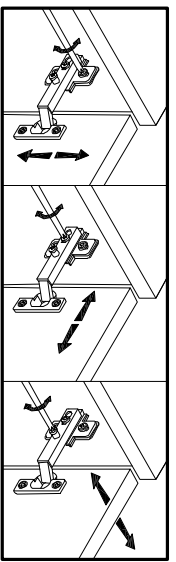
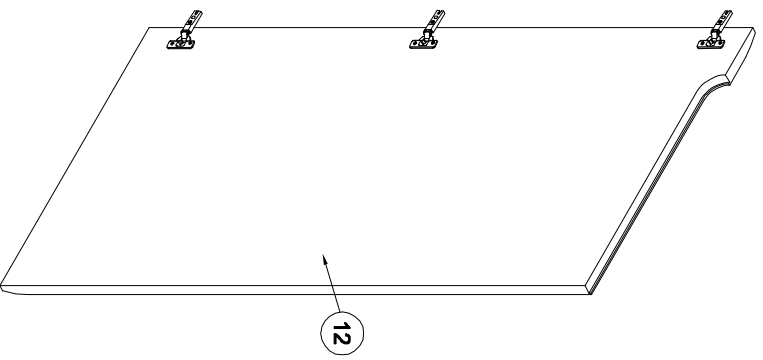
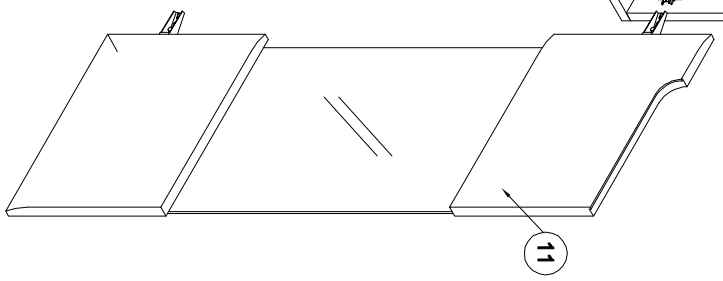
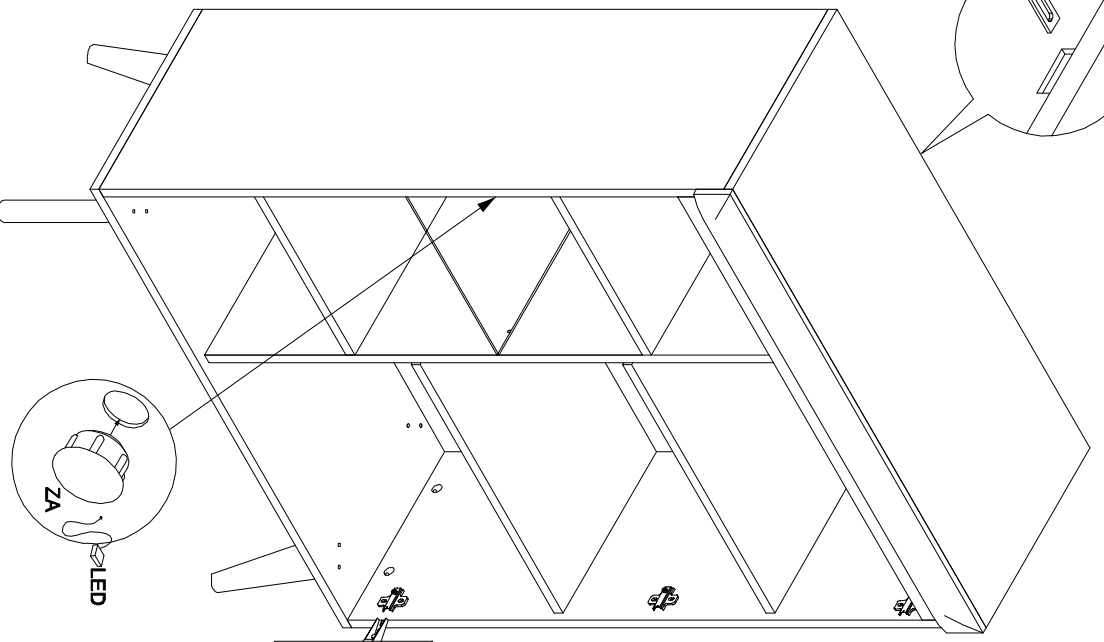
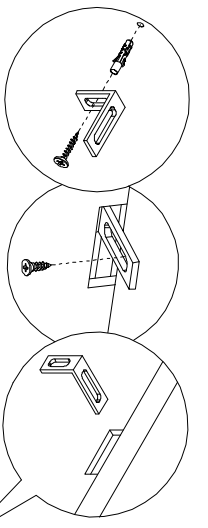

- NA 4x13 x1
- TB x1
- TA x1
- ZA x1