

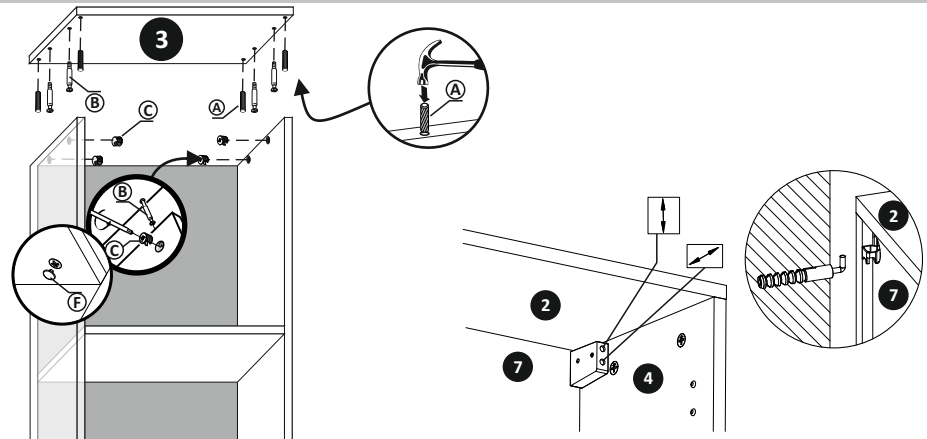

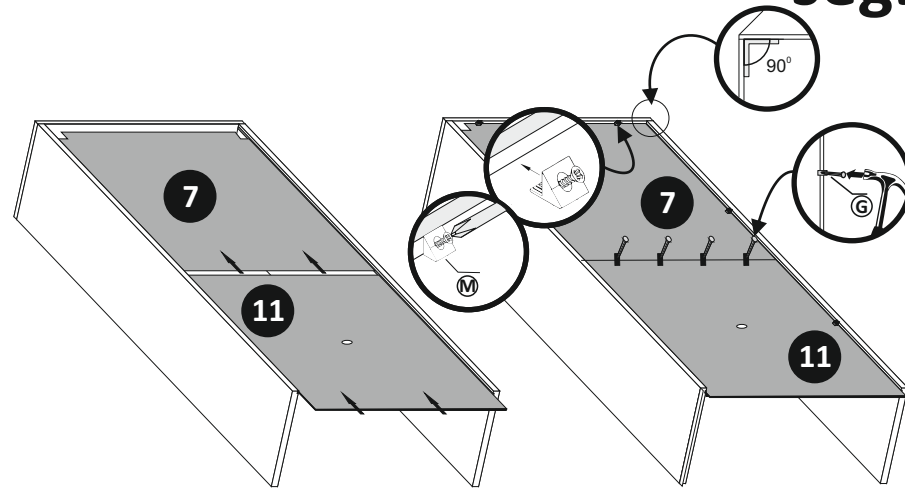

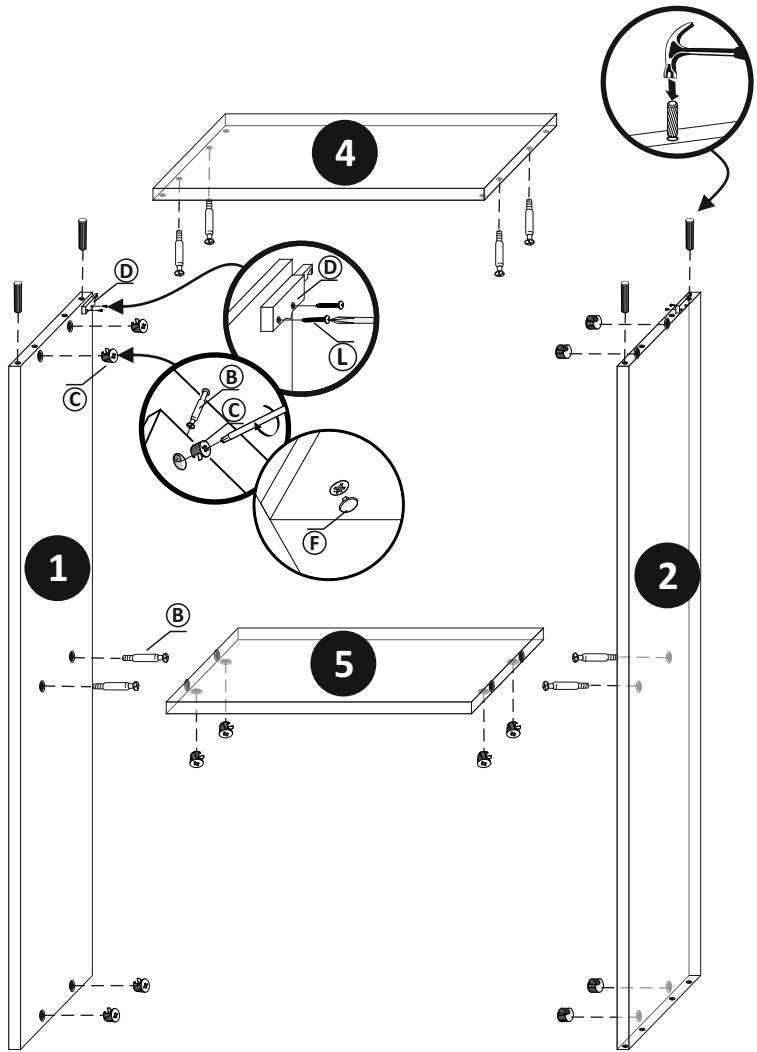

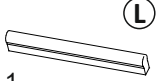

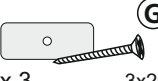

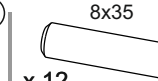
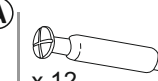
# seg. 20LR

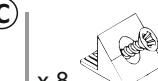

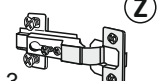
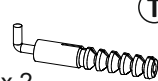
-  **L**  
x 1
-  **G**  
x 3 3x20
-  **F**  
x 12
-  **A**  
x 12 8x35
-  **B**  
x 12
-  **C**  
x 12
-  **M**  
x 8

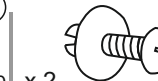
-  **S**  
x 1
-  **Z**  
x 3
-  **T**  
x 2
-  **L**  
x 6 4x30
-  **I**  
x 2
-  **D**  
x 2
-  **E**  
x 8
-  **X**  
x 6 4x16

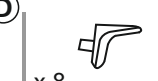
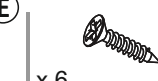