

# 3D

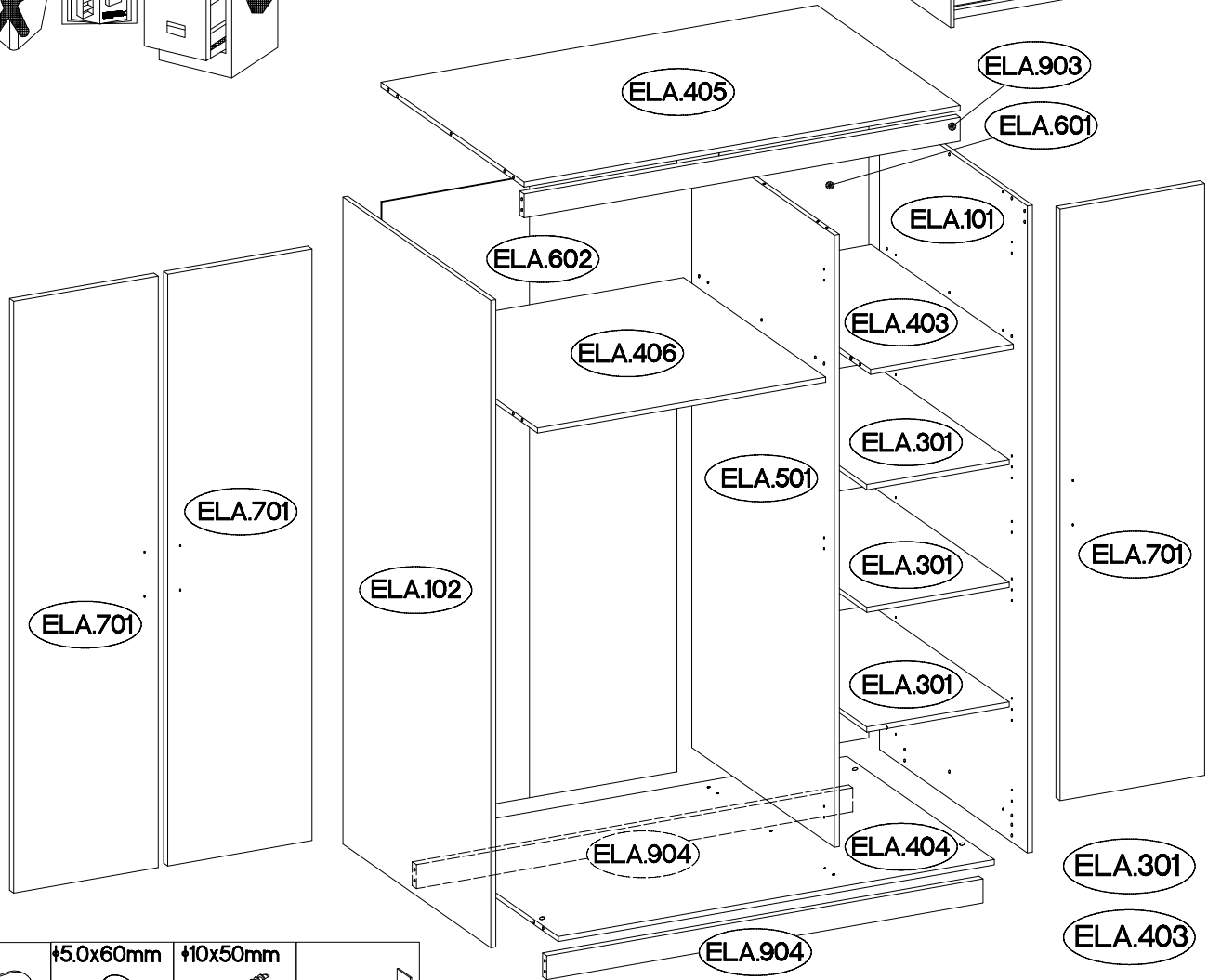

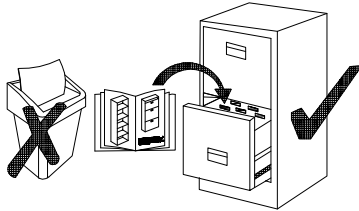

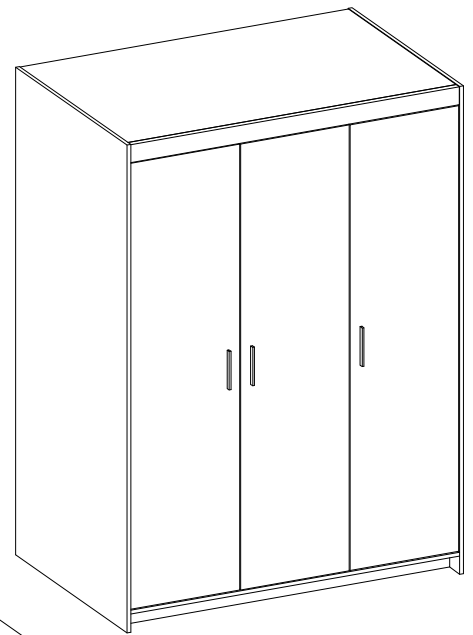

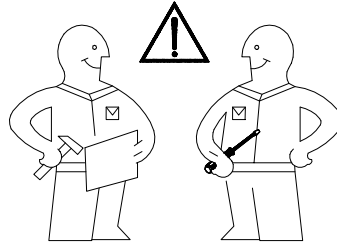
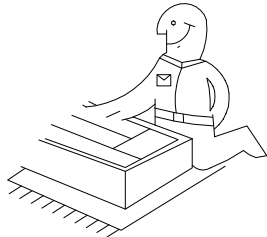
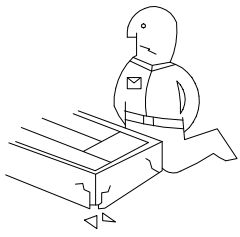



ELA.301  
 ELA.403 = max. 5kg  
 ELA.406

	$\pm 5.0 \times 60 \text{mm}$ 	$\pm 10 \times 50 \text{mm}$ 	
L2	P12	O7	L19
14	1	1	1

$\pm 35/16 \text{mm}$ 	H=0 	$\pm 3.5 \times 13 \text{mm}$ 	L=56mm 	6.5x48x16 	L=85mm 			$\pm 35/9 \text{mm}$ 	$\pm 4.0 \times 16 \text{mm}$ 	
G2	H	P5	D4	F2	J2	J17	J3	G1	P1	T3
6	9	22	2	4	1	2	12	3	4	2
$\pm 15/12 \text{mm}$ 		$\pm 8 \times 30 \text{mm}$ 	L=20mm 	L=128mm 	$\pm 4.0 \times 27 \text{mm}$ 	$\pm 3.0 \times 20 \text{mm}$ 	$\pm 15 \times 5 \text{mm}$ 			
C	E	A	D2	S11	R1	P7	F4			
20	20	42	16	3	6	66	2			

P-ISM-ELA-02

1

L=56mm 	∅15/12mm 	∅8x30mm 	L=20mm 	∅15x5mm 	∅4.0x16mm 		6.5x48x16 
D4	C	A	D2	F4	P1	T3	F2
2	20	42	16	2	2	2	4

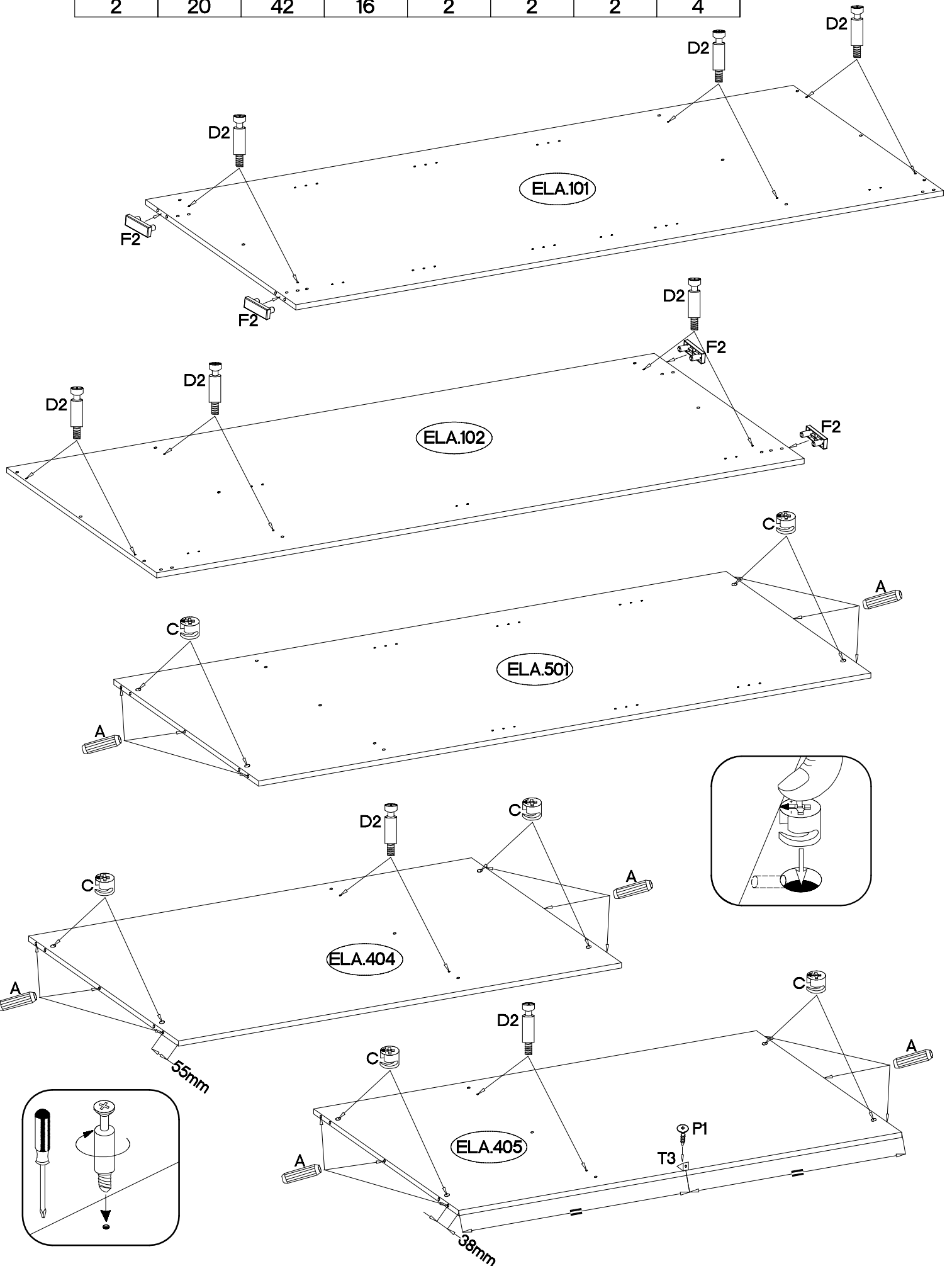

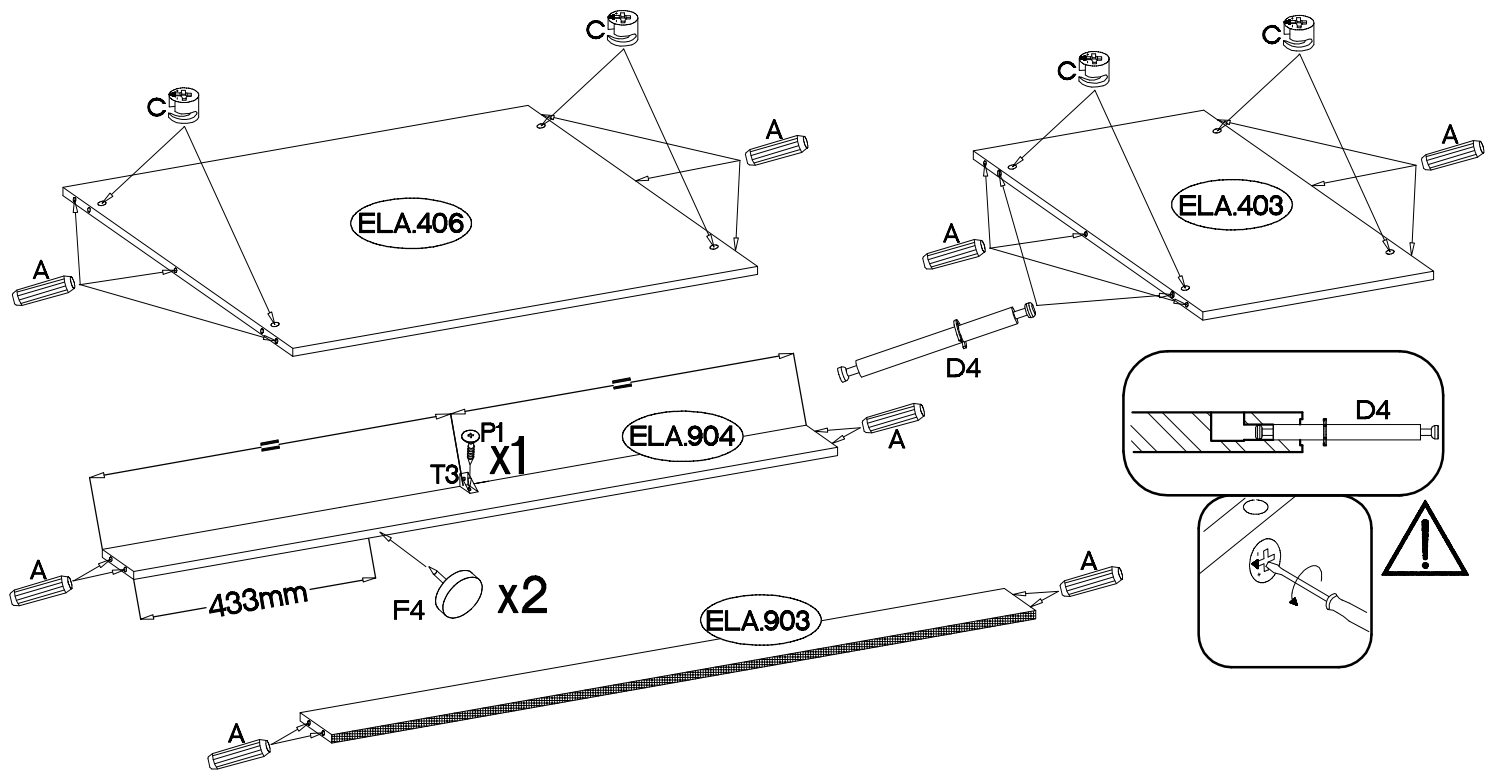

2

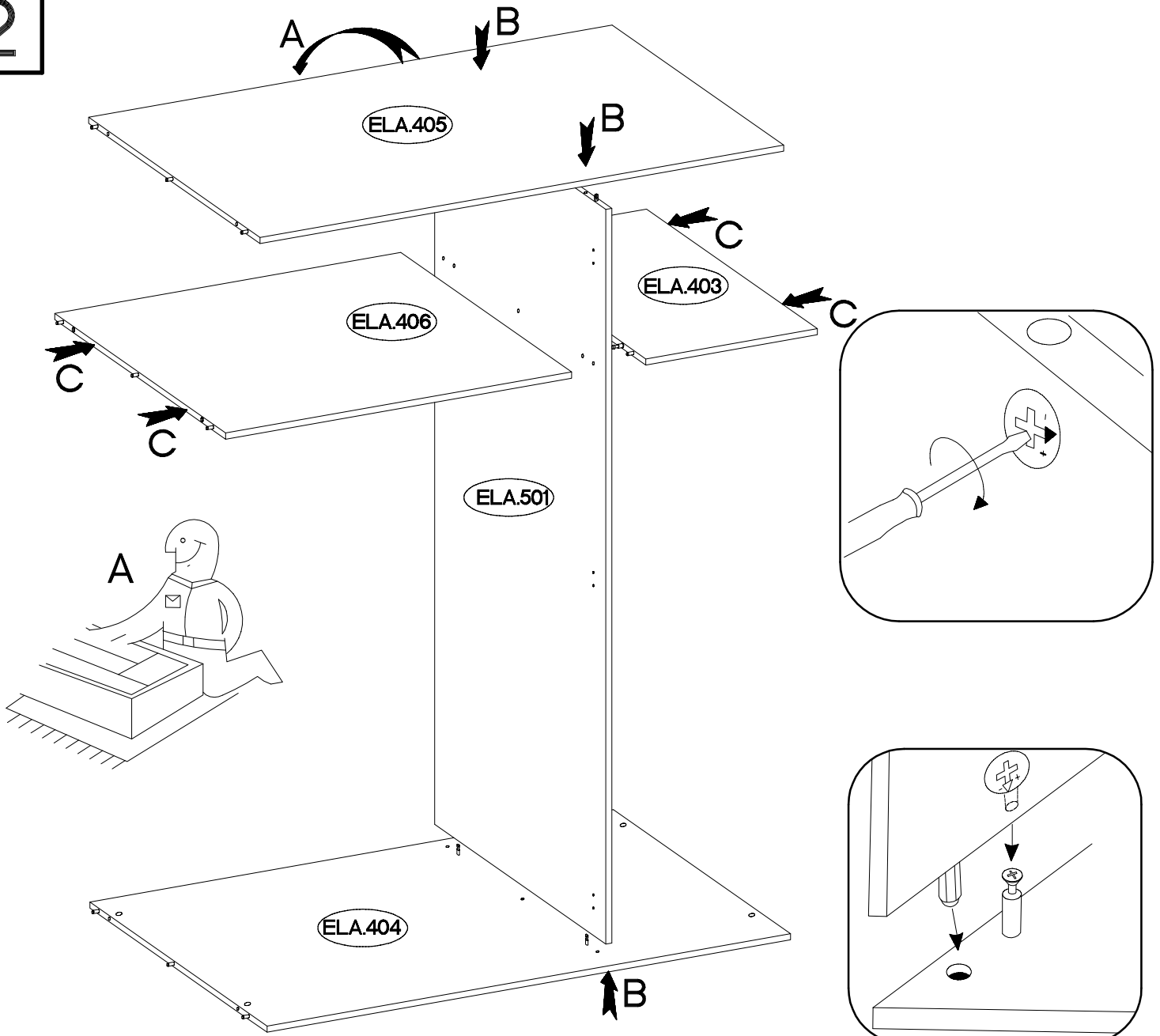

3

4.0x16mm



P1

2



ELA.903

ELA.101

ELA.102

ELA.904

ELA.904

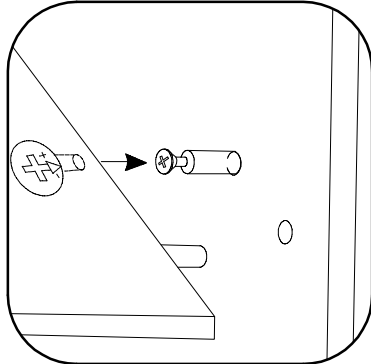
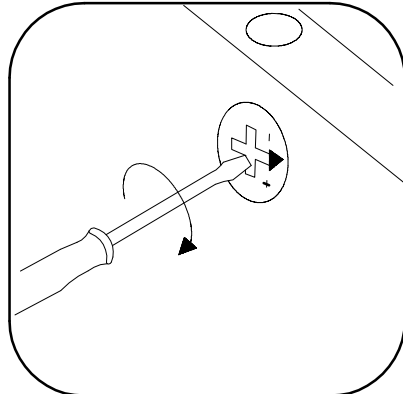
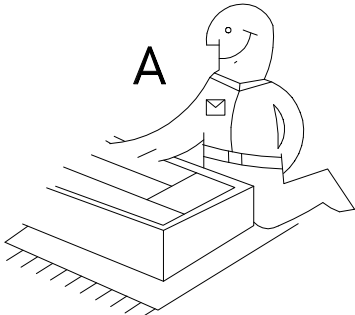
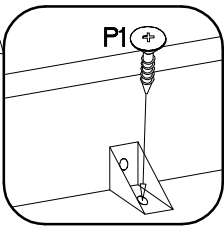

4



	±3.0x20mm
L2	P7
14	66

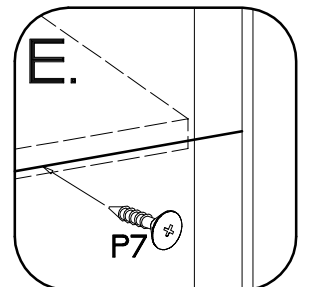
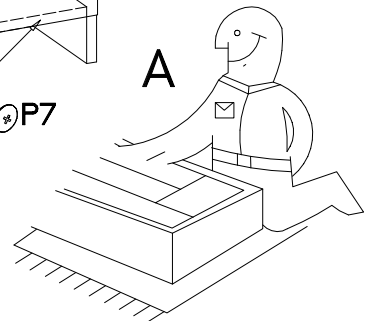
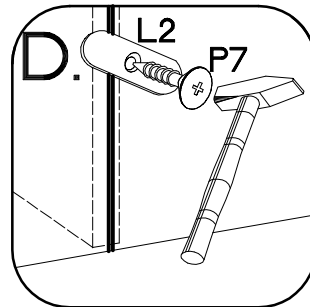
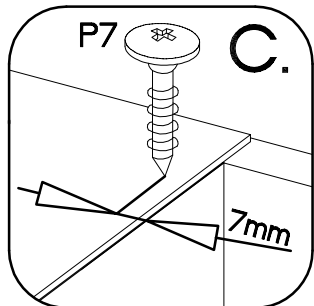
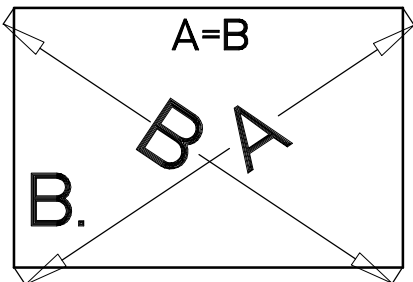
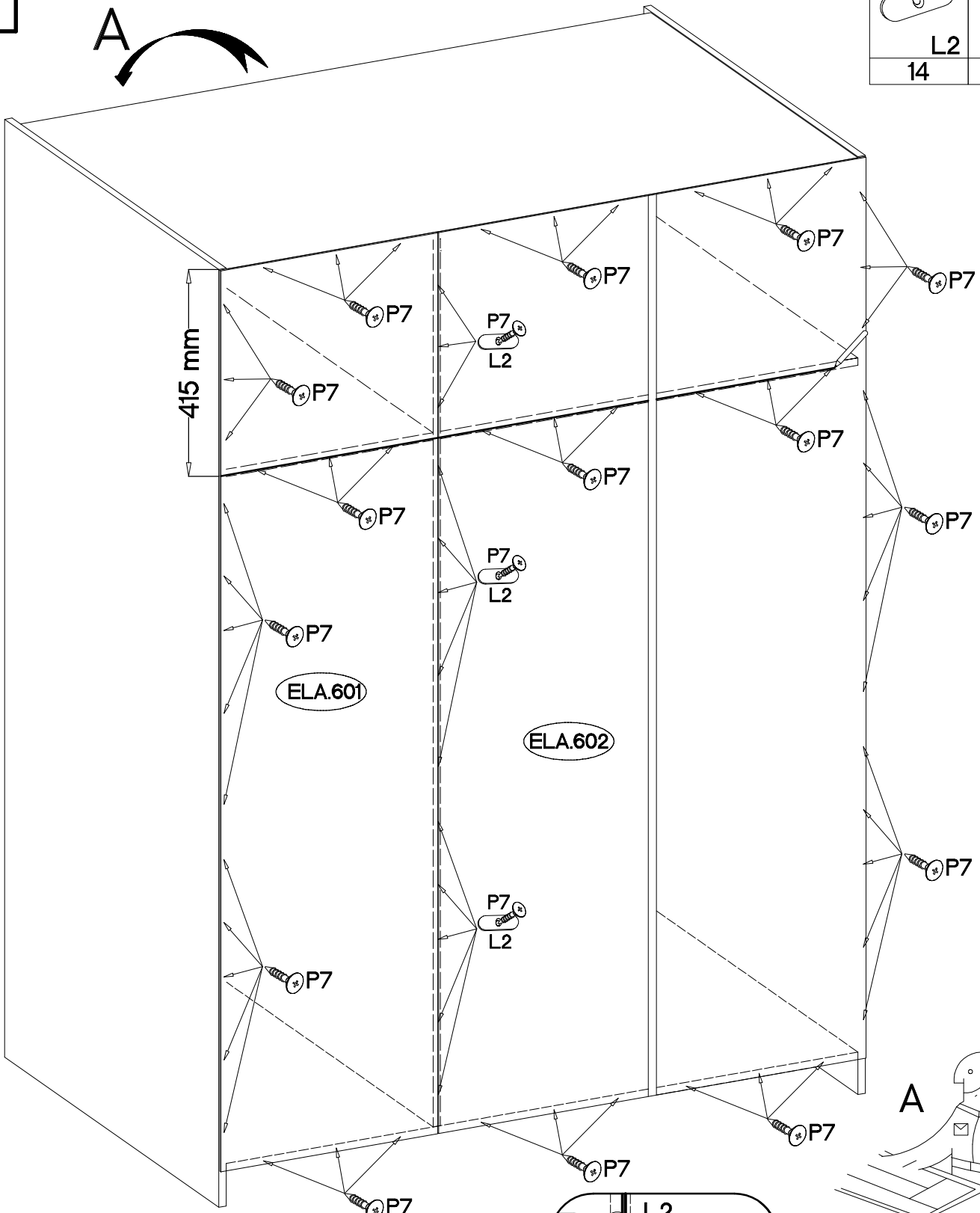



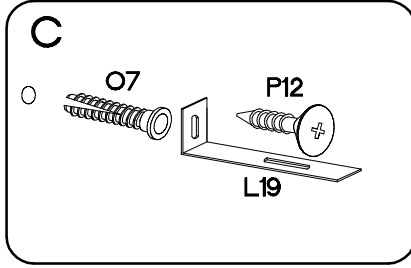
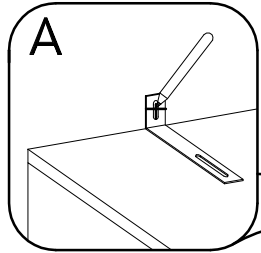
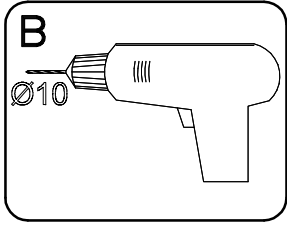

5

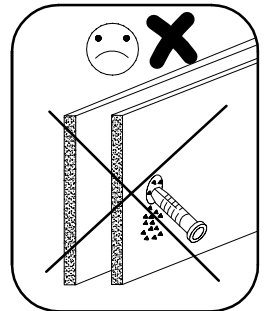
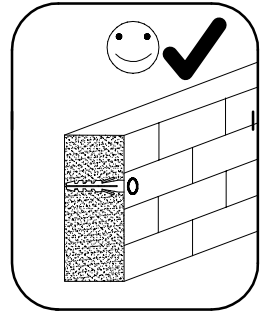
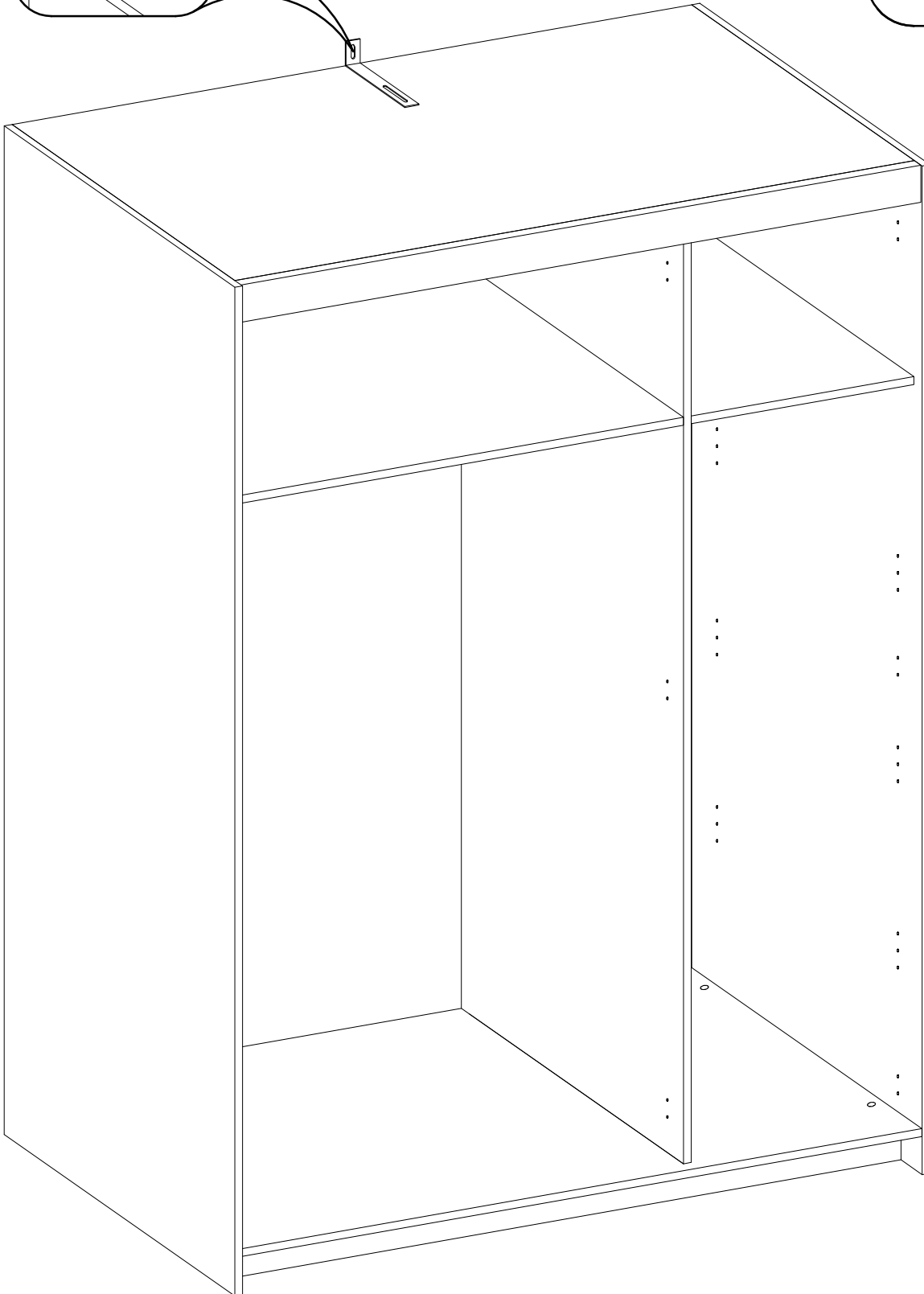
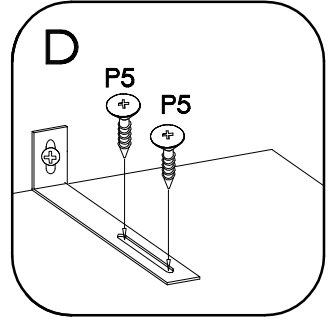

±5.0x60mm	±10x50mm		±3.5x13mm
P12	O7	L19	P5
1	1	1	2





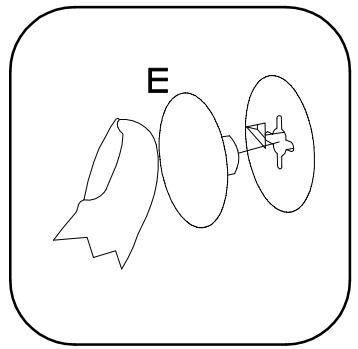
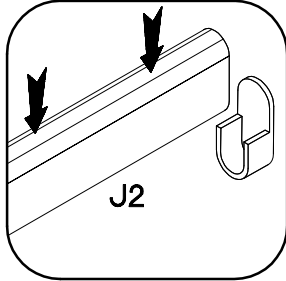
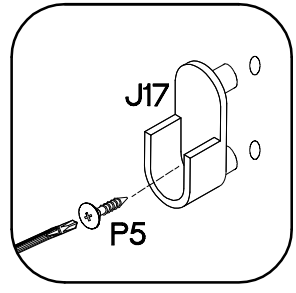
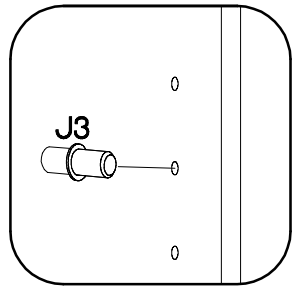
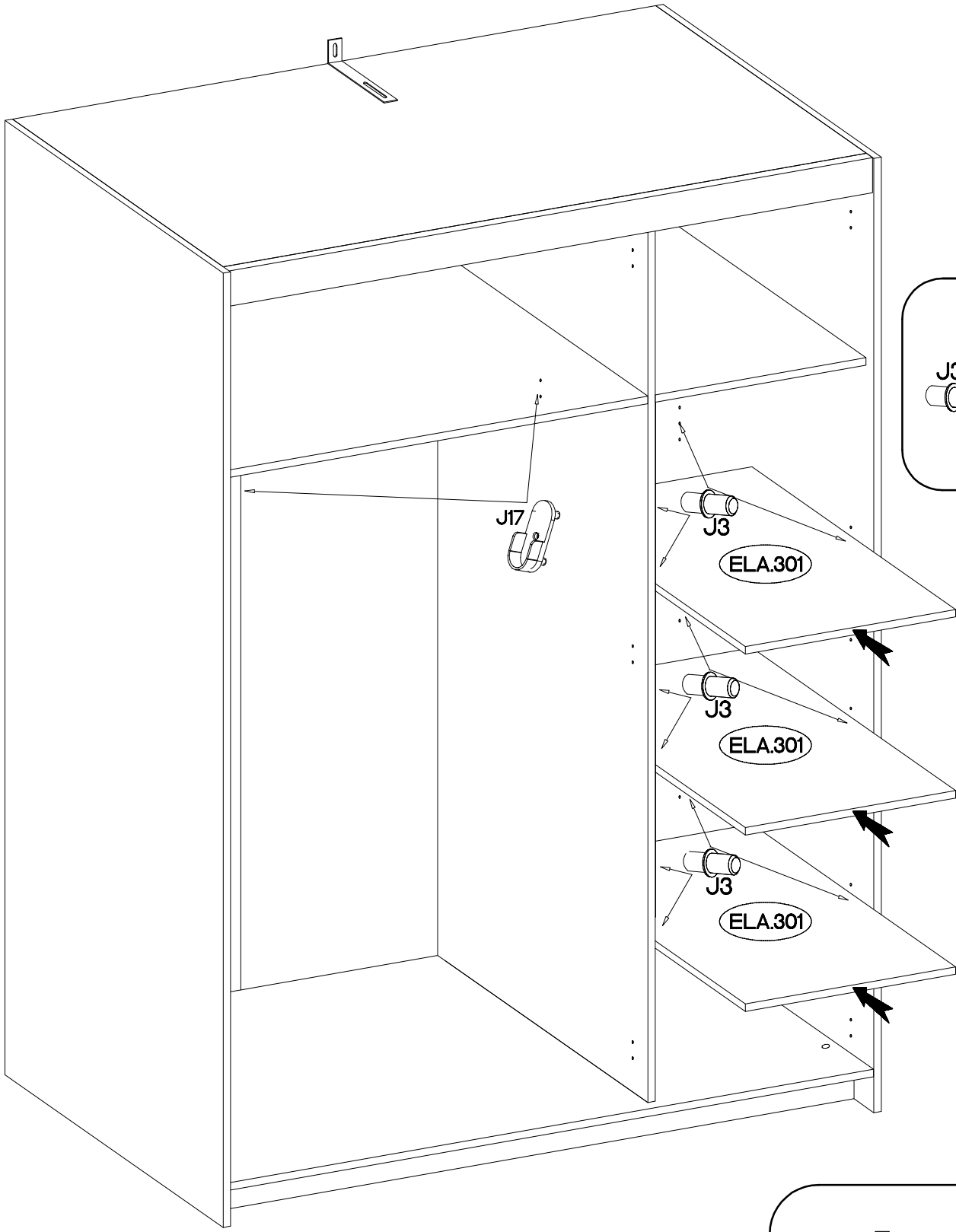

6

$\varnothing 3.5 \times 13 \text{mm}$ 	L=851mm 			
P5	J2	J17	J3	E
2	1	2	12	20



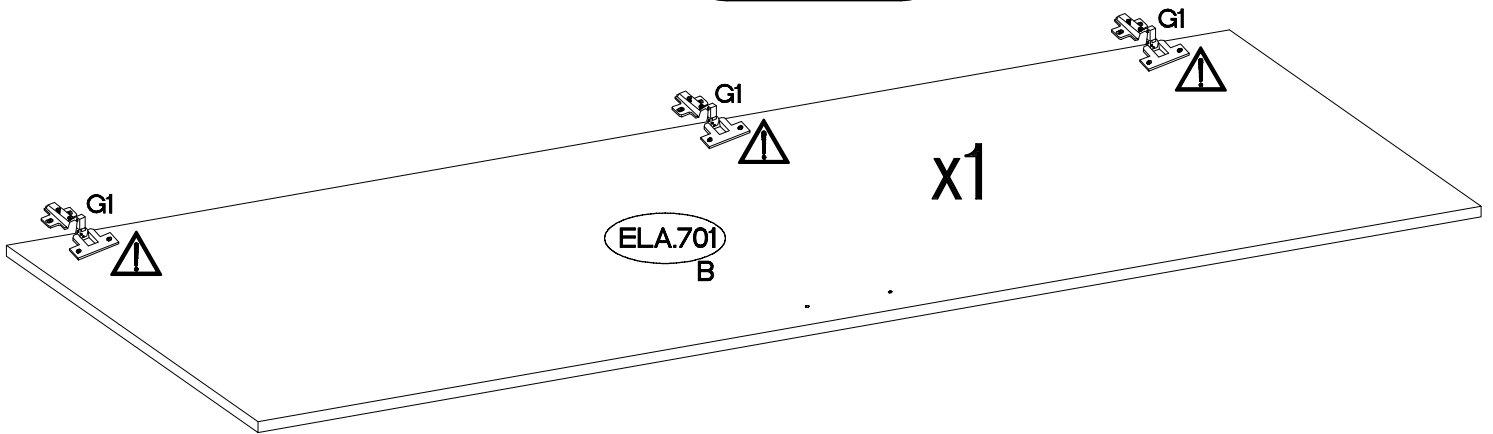
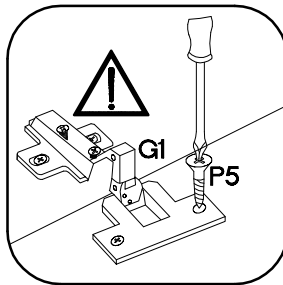
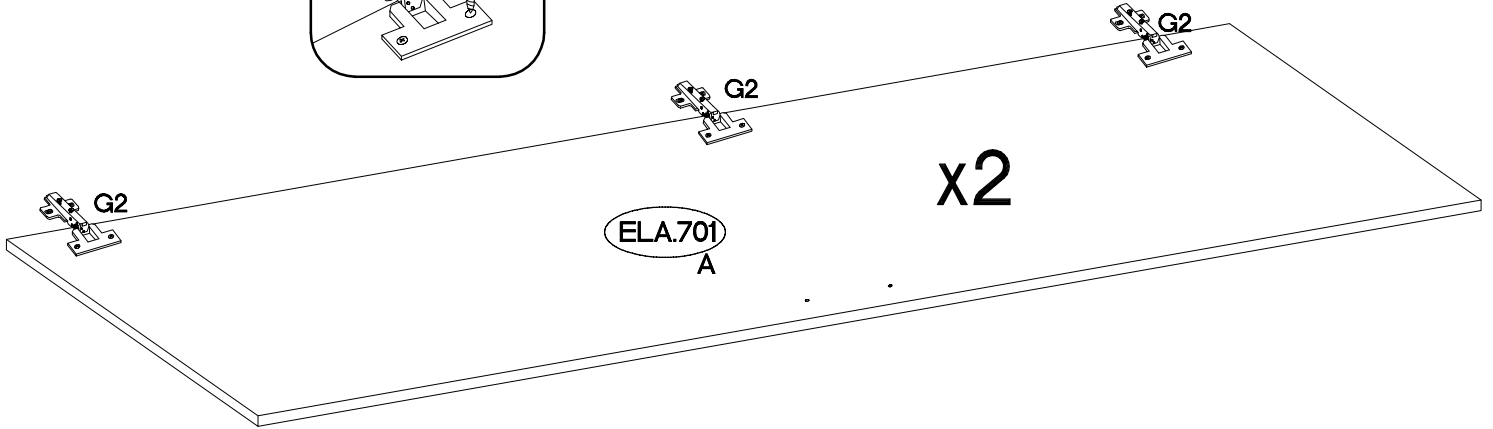
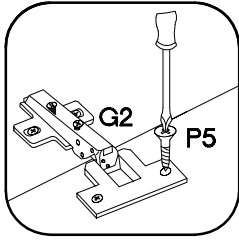
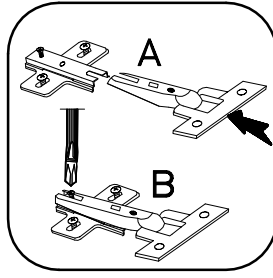

7

+35/16mm  G2 6	H=0  H 9	+3.5x13mm  P5 18	+35/9mm  G1 3
---	---	---	--



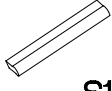

8

L=128mm	4.0x27mm
	
S11	R1
3	6

